

World leading PV Inverter Manufacturer

Macsol -TL3K/TL4K/TL5K

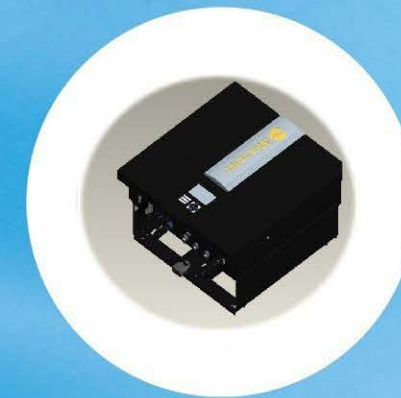

www.macsolar-power.com

Shanghai Macsolar Power Co.,Ltd

ADD.Level 4, 7/836 Shengli Road.Pudong,201201,Shanghai,P.R.China

TEL: +86-21-50720885 68689998

FAX: +86-21-50720639

E-mail:service@macsolar-power.com

User Manual

-Installation

-Operation

INDEX

Index.....	1
1. Notes on this manual.....	3
1.1 Scope of Validation.....	3
1.2 Symbols Used.....	4
1.3 Target Group.....	5
2. Preparation.....	6
2.1 System Demonstration.....	6
2.2 Safety Instructions.....	7
2.3 Explanations of Symbols on Inverter.....	9
3. Product Information.....	10
3.1 Overview.....	10
3.2 Major Characteristics.....	11
3.3 Datasheet.....	12
4. Unpacking.....	13
4.1 Assembly parts.....	13
4.2 Product Appearance.....	15
4.3 Product Identification.....	18
4.4 Further Information.....	19
4.5 Customer notice.....	19
5. Installation.....	20
5.1 Safety.....	20
5.2 Mounting Instructions.....	21
5.3 Safety Clearance.....	22
5.4 Mounting Procedure.....	23
5.5 Safety Lock.....	26
5.6 Check Varistors.....	28



- 6. Electrical Connection.....30**
 - 6.1 Safety30
 - 6.2 Overview of Connection Area.....31
 - 6.3 AC Side Connection.....33
 - 6.4 DC Side Connection36
 - 6.5 DC Side Adapter plug & Cable requirements42
 - 6.6 DC Side Disconnection43
 - 6.7 Communication and Monitoring Device44
- 7. Configuration.....45**
 - 7.1 LCD Display45
 - 7.2 Setup.....47
 - 7.3 Event number table.....53
 - 7.4 Further information for the event record54
- 8. Recycling and Disposal.....61**
- 9. Guaranty Scope and Guaranty Service.....62**
 - 9.1 Macsolar Factory Guaranty Scope.....62
 - 9.2 Guaranty Conditions.....62
 - 9.3 Guaranty Exclusion63
- 10. Contact.....64**
- 11. System Commissioning Confirmation Report.....65**
- Abbreviation.....71**

1. NOTES ON THIS MANUAL

1.1 Scope of Validation

The main purpose of this User's Manual is to provide instructions and detailed procedures for installing, operating, maintaining, and troubleshooting the following Macsolar Grid-Tied Solar Inverter:

- Macsol-TL3K
- Macsol-TL3.6K
- Macsol-TL4K
- Macsol-TL5K

Please keep this manual all time available in case of emergency.



1.2 Symbols Used



DANGER

DANGER indicates a hazardous situation which, if not avoided, will result in death or serious injury.



WARNING

WARNING indicates a hazardous situation which, if not avoided, can result in death or serious injury or moderate injury.



CAUTION

CAUTION indicates a hazardous condition which, if not avoided, can result in minor or moderate injury.



NOTICE

NOTICE indicates a situation that can result in property damage, if not avoided.



1.3 Target Group

Chapter 1, 2, 3, 4, 7, 8, 9, 10 and Chapter 11 are intended for anyone who is intended to use MacSolar Grid-Tied Solar Inverter. Before any further action, the operators must first read all safety regulations and be aware of the potential danger to operate high-voltage devices. Operators must also have a complete understanding of this device's features and functions.



WARNING

Do not use this product unless it has been successfully installed by qualified personnel in accordance with the instructions in Chapter 5, "Installation".

Chapter 5, and Chapter 6 are only for qualified personnel who is intended to install or uninstall the MacSolar Grid-Tied Solar Inverter.



NOTICE

Hereby qualified personnel means he/she has the professional training, knowledge, and experience in:

- Installing electrical equipment and PV power systems (up to 1000 V).
- Applying all applicable installation codes.
- Analyzing and reducing the hazards involved in performing electrical work.
- Selecting and using Personal Protective Equipment (PPE).

All installation, commissioning, maintenance, repair and recycling of MacSolar Inverter must be done only by qualified personnel.

2. PREPARATION

2.1 System Demonstration

Solar energy generation systems, based on photovoltaic modules, nowadays represent the most suitable solution, in particular for domestic power levels, to reduce the energy consumption produced by oil and gas. Moreover in different European countries, electricity companies are providing money incentives for the energy produced by renewable sources and injected into the utility grid.

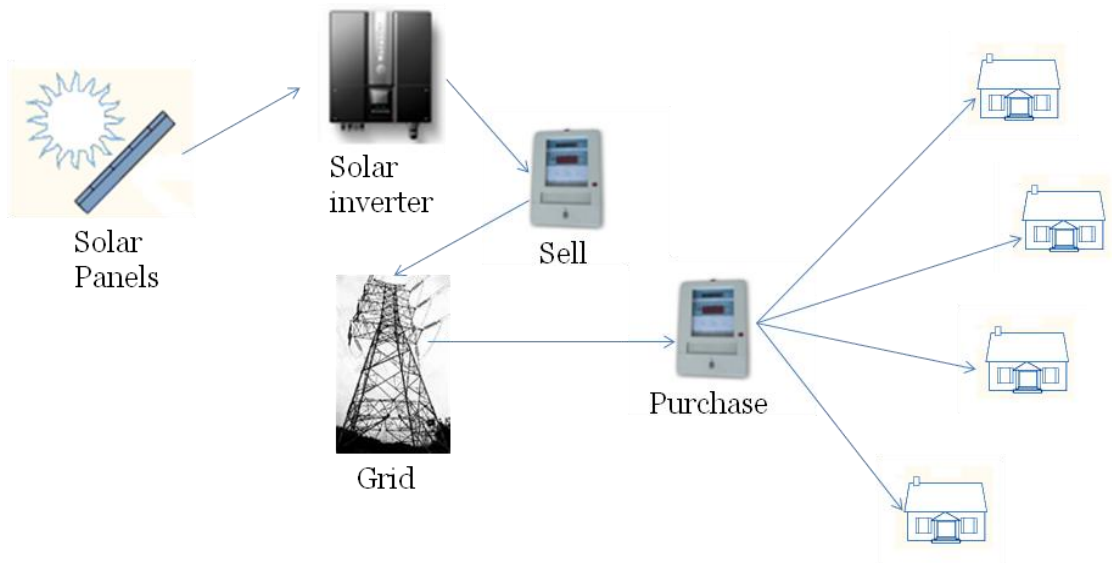

The solar inverter is a critical component in a solar energy system. It performs the conversion of the variable DC output of the PV modules into a clean sinusoidal 50 or 60 Hz AC current that is then applied directly to the commercial electrical grid or to a local grid electrical network. Typically, communications capability is included so users can monitor the inverter and report on power and operating conditions, provide firmware updates and control the inverter grid connection. Depending on the grid infrastructure wired (RS-485, CAN, Power Line Communication, Ethernet) or wireless (Bluetooth, ZigBee/IEEE802.15.4, 6LoWPAN) networking options can be used.



2.2 Safety Instructions



DANGER

DANGER due to electrical shock and high voltage

DO NOT touch the operating component of the inverter, it might result in burning or death.

TO prevent risk of electric shock during installation and maintenance, please make sure that all AC and DC terminals are plugged out.

DO NOT touch the surface of the inverter while the housing is wet, it might lead to electrical shock.

DO NOT stay close to the instruments while there are severe weather conditions including, storm lighting, and etc.



WARNING

The installation service recycling and disposal of the inverters must be performed by qualified personnel only in compliance with national and local standards and regulations. Please contact your dealer to get the information of authorized repair facility for any maintenance or repairmen.

Any unauthorized actions including modification of product functionality of any form will affect the validation of warranty service, MacSolar may deny the obligation of warranty service accordingly.



CAUTION

The PV inverter will become hot during operation please don't touch the heat sink or peripheral surface during or shortly after operation.

Risk of damage due to improper modifications.

Never modify or manipulate the inverter or other components of the system.



NOTICE











Public utility only

The PV inverter designed to feed AC power directly to the public utility power grid, do not connect AC output of the device to any private AC equipment.

The electricity just for consult in the Arm board of inverter, not use for calculate



2.3 Explanations of Symbols on Inverter

Symbol	Description
	Dangerous electrical voltage This device is directly connected to public grid, thus all work to the inverter shall only be carried out by qualified personnel.
	DANGER to life due to high electrical voltage! There might be residual currents in inverter because of large capacitors. Wait 10 MINUTES before you remove the front lid.
	NOTICE, danger! This device directly connected with electricity generators and public grid.
	Danger of hot surface The components inside the inverter will release a log of heat during operation, DO NOT touch aluminum housing during operating.
	A record has occurred Please go to Chapter 7.4 “ Further information for the event record” to remedy the record.
	This device SHALL NOT be disposed of in residential waste Please go to Chapter 8 “Recycling and Disposal” for proper treatments.
	Without Transformer This inverter does not use transformer for the isolation function.
	German mark of conformity The inverter complies with the requirement of the German Grid Regulations.
	Certified Safety The inverter complies with the requirements of the Equipment and Product Safety Act in Europe.
	CE Mark Equipment with the CE mark fulfils the basic requirements of the Guideline Governing Low-Voltage and Electromagnetic Compatibility.
	No unauthorized perforations or modifications Any unauthorized perforations or modifications are strictly forbidden, if any defect or damage (device/person) is occurred, Macsolar shall not take any responsibility for it.

3. PRODUCT INFORMATION

3.1 Overview

Industrial Layout

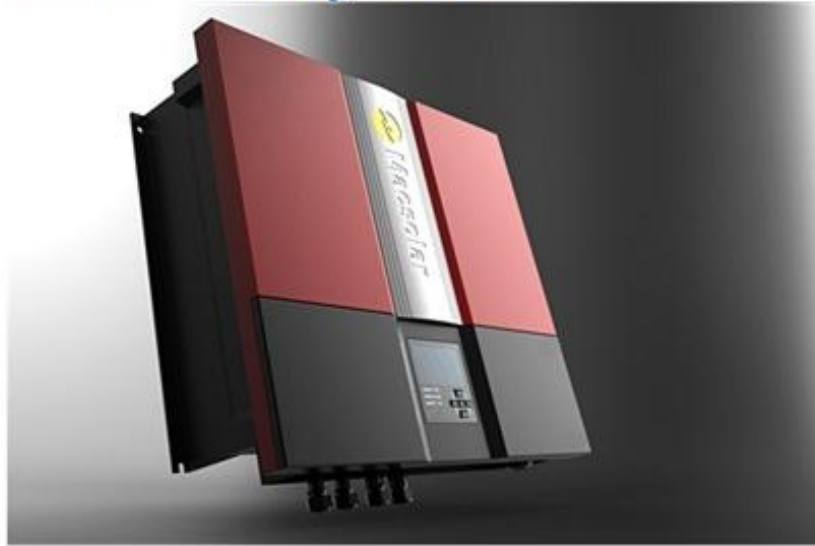

Reduced Heat Sink

Cut the overall machine weight

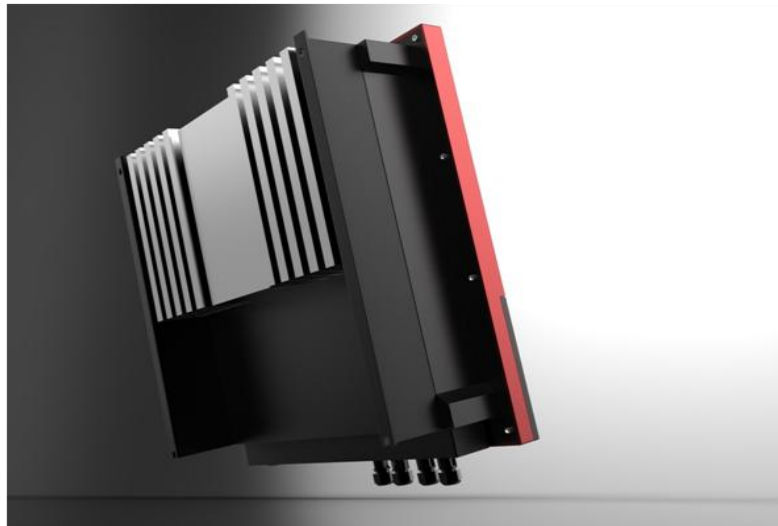



Shield

Protection for DC/AC/Monitoring Connections

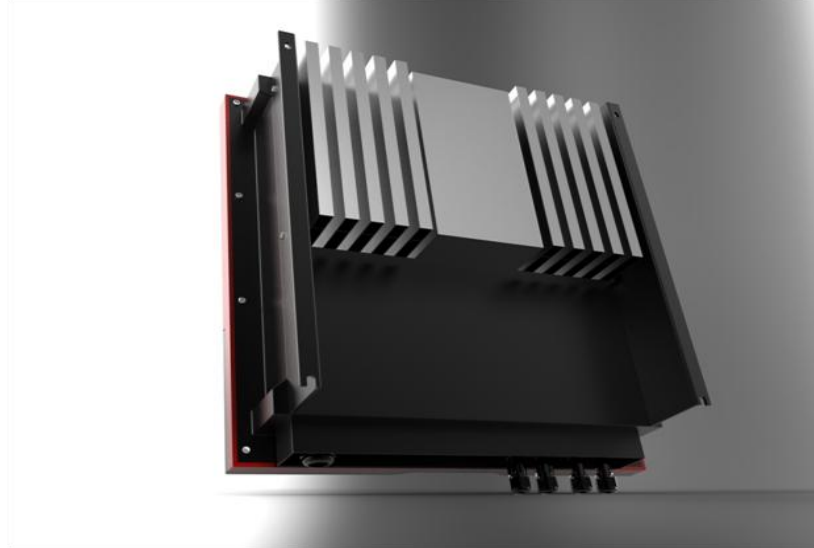

3.2 Major Characteristics

MacSolar inverter has following characteristics which make MacSolar inverter “High Efficiency, High Reliability, High Cost Effective Ratio”

- High DC input voltage, can be connected with more PV panels.
- Wide MPPT voltage range can fit in different locations or various weather conditions.
- High MPP tracking accuracy, catch most of energy from panels and converts it into money in your pocket.
- Complete set of protection methods.

Also, following protection methods are integrated in MacSolar inverter:

- Internal overvoltage
- DC insulation monitoring
- Ground fault protection
- Grid monitoring
- Ground fault current monitoring
- DC current Injection monitoring
- Integrated DC switch



3.3 Datasheet

Type	Macsol-TL3K		Macsol-TL3.6K		Macsol-TL4K		Macsol-TL5K	
Input (DC)								
Max. DC Power [W]	3400		4100		4550		5650	
Max. DC Voltage [V]	580							
MPPT Input Voltage Range [V]	125 – 480							
Turn off DC voltage[V]	100		100		100		100	
Activation voltage [V]	150		150		150		150	
Number of DC Connection Sets	2		2		2		2	
Number of MPP Trackers	Single/Double(Optional)		Single/Double(Optional)		Single/Double(Optional)		Double	
Max. Input Current	Single	21	Single	21	Single	21	–	
Single/Double Current [A]	Double	12/12	Double	12/12	Double	12/12	14/14	
Max. Input Power	Single	3400	Single	4100	Single	4550	–	
Single/Double MPPT [W]	Double	2170/2170	Double	2580/2580	Double	2870/2870	3100/3100	
DC Connection	Amphenol Helios 4							
DC Switch	Optional							
Output (AC)								
Rated AC Power [W]	3000		3600		4000		5000	
Max. AC Power [W]	3300		3680		4400		5500	
Rated AC Current [A]	13.0		15.6		17.4		21.8	
Max. AC Current [A]	14.4		16		19.1		24.0	
Grid Voltage/Frequency Range	According to AS4777, C10/11, ENEL Guide 2010, G83, RD1663, VDE 0126–1–1							
Power Factor(cos Φ)	> 0.99(full load)							
AC Current Distortion (THD)	< 3%							
AC Connection	WIELAND 96–032–5054–3							
Efficiency								
Max. Efficiency	97.5%		97.6%		97.6%		97.6%	
Euro Efficiency (at 360Vdc)	96.5%		97.0%		97.0%		97.0%	
MPPT Accuracy (static)	99.5%		99.5%		99.5%		99.5%	
Protection								
Internal Overvoltage Protection	Yes							
DC Insulation Monitoring	Yes							
DC/AC Side Varistors	Yes							
Direct Current Monitoring	Yes							
Ground Fault Current Monitoring	Yes							
Grid Monitoring	Yes							
Short Current Protection	Yes							
Thermal Derating Protection	Yes							
Interface								
LCD Display	128 x 64 Pixels, Backlight							
Display Language	English							
Datalogger & Communication	RS485, Ethernet(Optional), GPRS(Optional), Wireless(Optional)							
Other Data								
Isolation	Transformerless							
Operating Temperature Range	–20°C to +60°C				–20°C to +60°C(40°C to 60°C with derating)			
Cooling Method	Natural Convection							
Relative humidity	0% to 98% Non Condensing							
Noise Emission[dBA]	< 40							
Operation Altitude[m]	< 2000							
Consumption at Night [W]	< 0.1							
IP Protection	IP65							
Dimensions (WxHxD) [mm]	496 x 515 x 195							
Weight[kg]	Single	19.8	Single	19.8	Single	19.8	–	
	Double	22.2	Double	22.2	Double	22.2	22.3	
Standard Warranty [Year]	5 / 10 (Optional)							
Safety Class Compliance	AS3100, IEC62109-1/2							
EMC Compliance EMC	EN61000–6–2, EN61000–6–3, EN61000–3–2, EN61000–3–3, EN61000–3–11, EN61000–3–12							
Grid Protection Compliance	According to AS4777, C10/11, ENEL Guide 2010, G83, RD1663, VDE 0126–1–1							



4. UNPACKING

4.1 Assembly parts

After you receive the Mac solar inverter, please check if there is any damage on the carton. Also, please check the inside completeness and for any visible external damage on the inverter or any accessories. Contact your dealer if anything is damaged or missing.

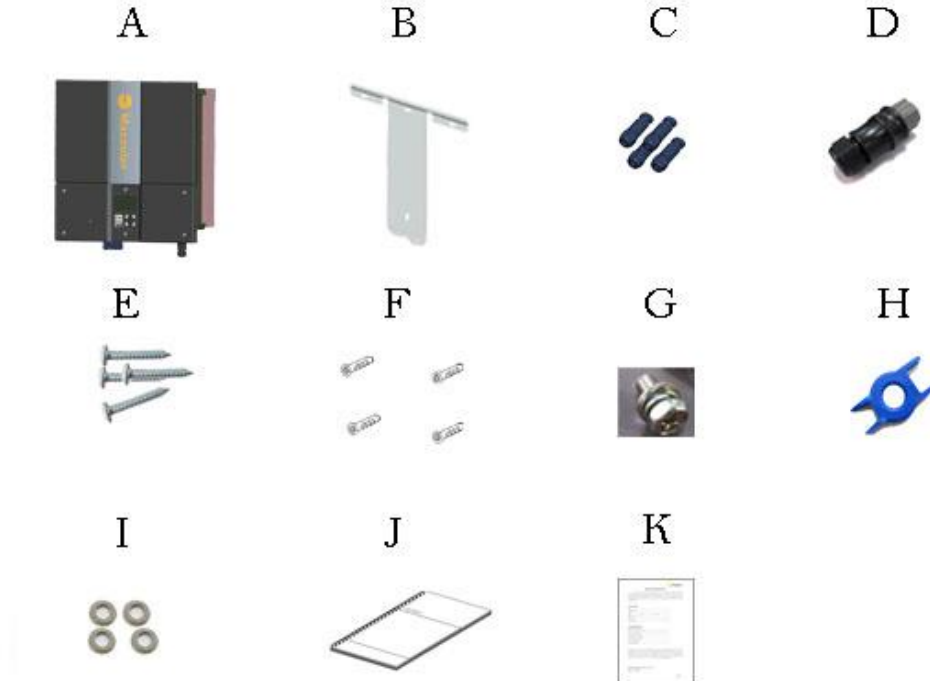



Object	Quantity	Description
A(customized)	1	Inverter Macsol-TL3K
A1(customized)	1	Inverter Macsol-TL3.6K
A2(customized)	1	Inverter Macsol-TL4K
A3(customized)	1	Inverter Macsol-TL5K
A4(customized)	1	Inverter Macsol-TL3K(2MPPT)
A5(customized)	1	Inverter Macsol-TL3.6K(2MPPT)
A6(customized)	1	Inverter Macsol-TL4K(2MPPT)
B	1	Rear panel
C	1sets or 2 sets	DC connector
D	1	AC connector
E	4	ST6×50 Expansion screw
F	4	Expansion tube
G	1	M6×12 cross recessed pan head screw and washer connecting the rear panel with inverter
H	1	Ring tool to disconnect DC connector
I	4	Washer Φ 6
J	1	Installation guide, including user manual
K	1	Quality certificate card

4.2 Product Appearance

Front:

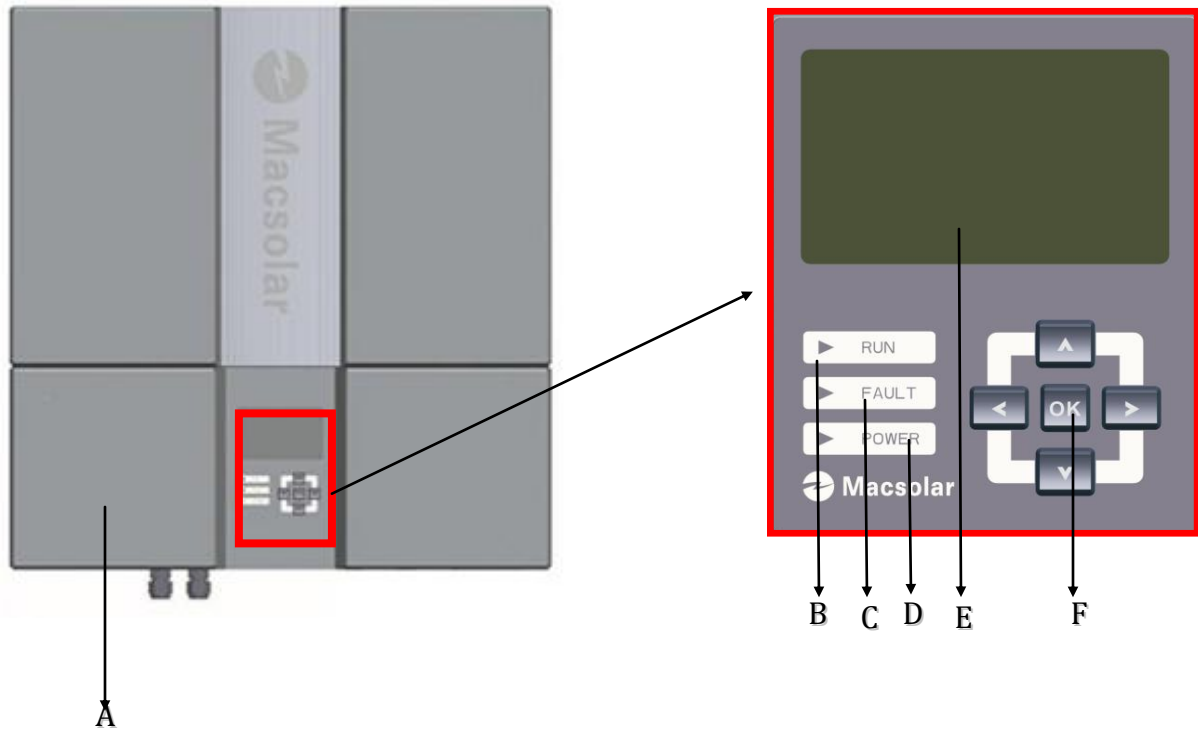

Object	Description
A	Removable front lid for potential maintenance and repair
B	LED light-RUN
C	LED light-FAULT
D	LED light-POWER
E	LCD screen for checking the operating status and configuration
F	Control keyboard for displays and configuration of parameters

Bottom:

Single - input MPPT display picture

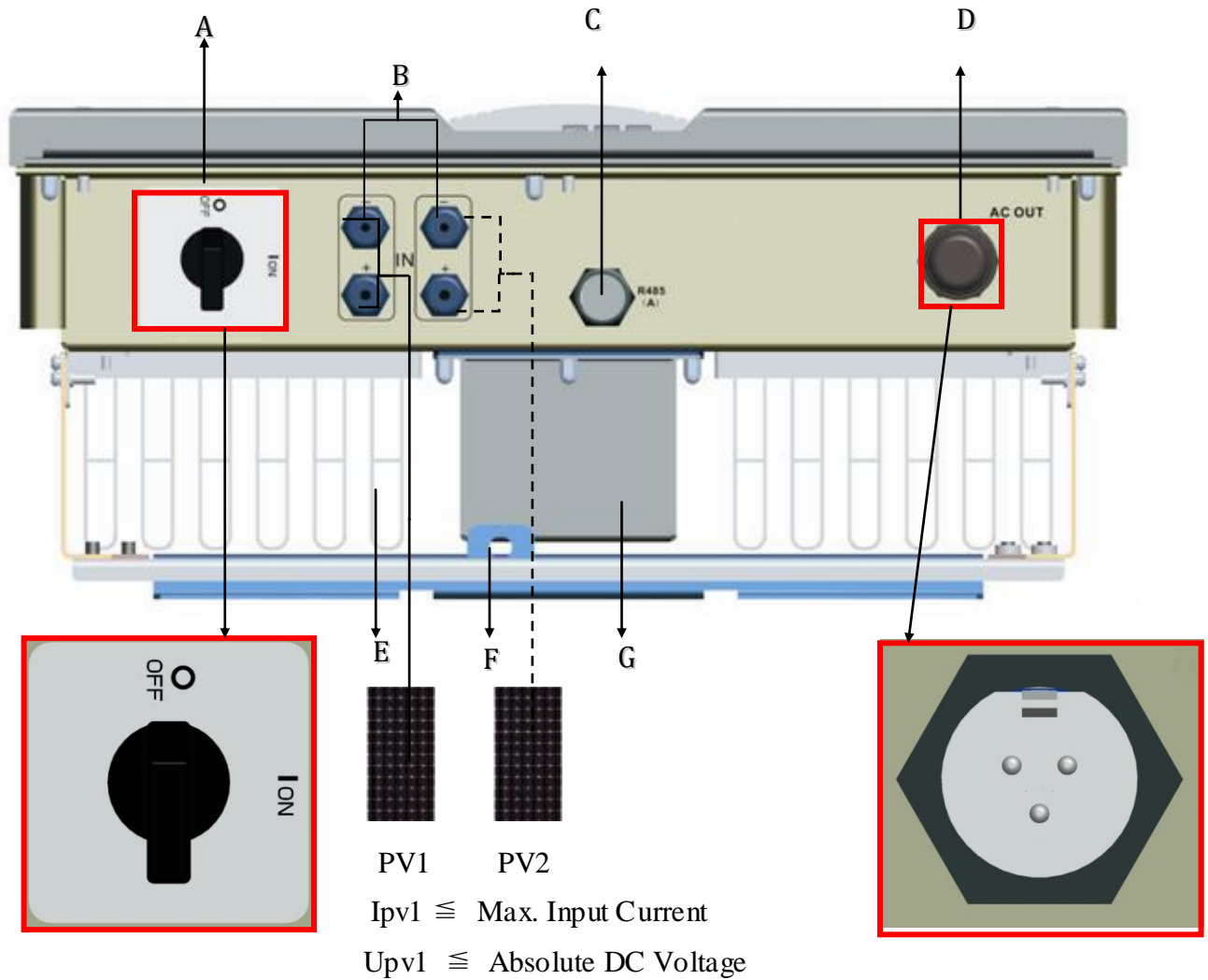

Object	Description
A	DC switch to turn off the inverter manually
B	DC input , Anode connected with anode ,cathode connected with cathode, the summation of two route import electricity \leq inverter the biggest import electricity , the same two route pressure and import pressure \leq inverter the biggest import pressure.
C	Plugs for connecting the RS485 communication module.
D	AC output
E	Heat sink
F	Extra lock
G	Inductor box

Dual-input MPPT display picture

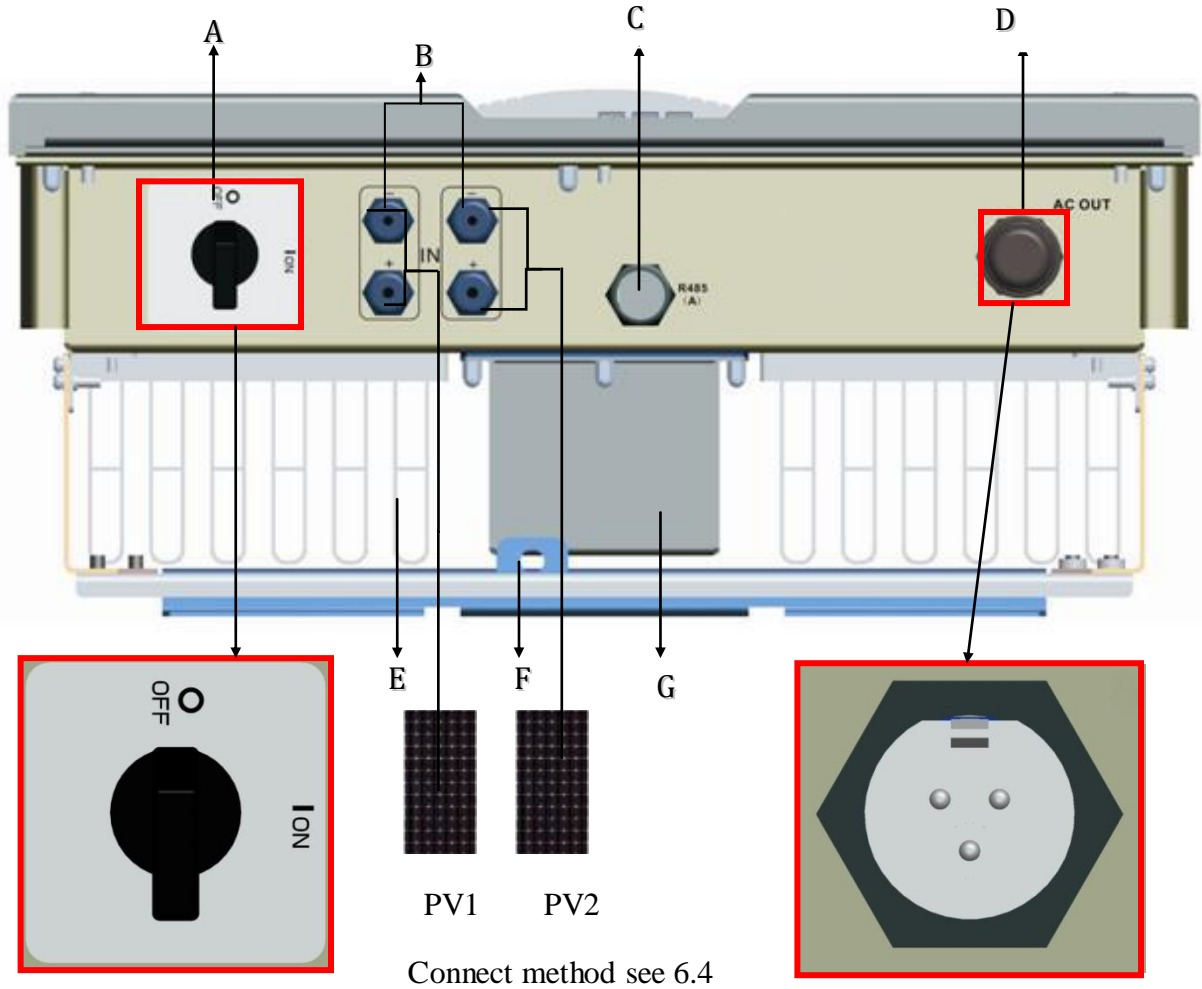

Dual-input MPPT independent connection

Object	Description
A	DC switch to turn off the inverter manually
B	DC input
C	Plugs for connecting the RS485 communication module.
D	AC output
E	Heat sink
F	Extra lock
G	Inductor box

4.3 Product Identification

You can identify the inverter by the side type label. Information such as serial number (SN.), type of the inverter, as well as inverter specifications are specified on the side type label. The type label is on the middle part of the right side of the inverter housing.

(Side type label example as on Macsol-TL5K)

MacSolar Made in China
www.macsolar-power.com

Type:Macsol-TL5K(Dual MPPT)

	DC :	
	V _{DC max} :	580V
	V _{DC MPP} :	125-480V
	P _{DC max} :	5650W
	I _{DC max} :	15A/15A
	AC :	
	V _{AC nom} :	230V
	f _{AC nom} :	50Hz
	P _{AC nom} :	5000W
	I _{AC nom} :	21.8A
cos φ:	0.99	

IP 65, outdoor
 -20°C to +60°C
 Protection Class I
 Overvoltage Cat.III
 AS4777.2/3; C10/11;
 ENEL Guide; G83/1; AS3100;
 VDE0126-1-1/VDE-AR-N4105;
 IEC62109-1; IEC62109-2.









TEL: +86 21 50720885
 E-mail: service@macsolar-power.com
 ADD: Level 4,7/836 Shengli Road,
 Pudong,201201,Shanghai
 P.R.China.

S/N └



4.4 Further Information

If you have any further questions concerning the type of accessories or installation, please check our website www.macsolar-power.com or contact our service hotline.

4.5 Customer notice

After purchase this product, post guarantee slip back to company, or take a picture of guarantee slip, upload the electron picture on the website, our company can supply the service for the customer, no guarantee slip ,the company will not irresponsible for the customer.

Address: Level 4, 7/836 Shengli Road, Pudong, 201201, Shanghai, P.R. China

Tel: (+86)-21-50720885 / (+86)-21-68689998

Fax: (+86)-21-50720639

Consignee: SHANGHAI MACSOLAR POWER CO.,LTD

website: www.macsolar-power.com



5. INSTALLATION

5.1 Safety



DANGER

DANGER to life due to potential fire or electricity shock.

DO NOT install the inverter near any inflammable or explosive items.

This inverter will be directly connected with HIGH VOLTAGE power generation device, the installation must be performed by qualified personnel only in compliance with national and local standards and regulations.

Setting the inverter, do not set the inverter under the range of sunshine. Suggest set back PV or under eave, avoid the sun shine shooting straight.



NOTICE

NOTICE due to the inappropriate or the harmonized installation environment may jeopardize the life span of the inverter.

Installation directly expose under intensive sunshine is not recommended.

The installation site **MUST** have good ventilation condition.



5.2 Mounting Instructions

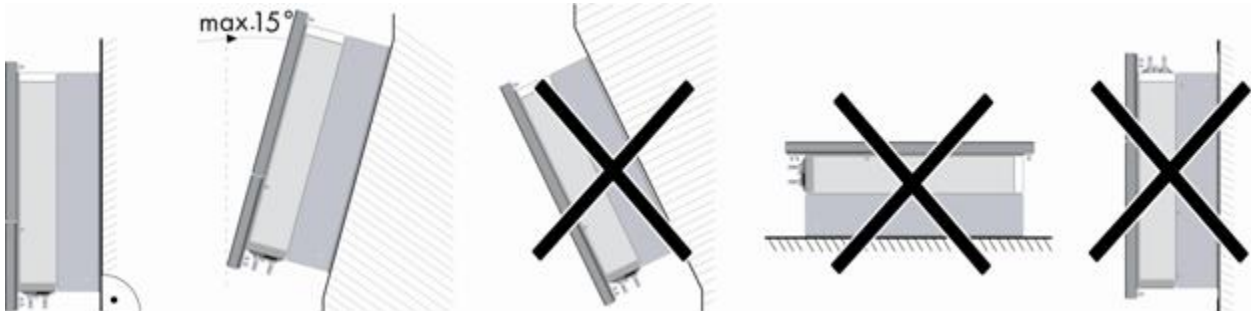

- Mac solar inverter is designed for installation both indoors and outdoors
- Please only mount the inverter in the direction as illustrated above
- Installation of the inverter in the vertical direction is recommended
- Tilted backwards by max.15 degree is allowed
- Never install the device with a forward tilt, horizontally or even upside down
- For the convenience of checking the LCD display and possible maintenance activities, please install the inverter at eye level
- Make sure the wall you selected is strong enough to handle the screws and the weight of the inverter
- Ensure the device is properly fixed to the rear panel
- It is not recommended to install the inverter directly exposed in strong sunshine, the excess heating might lead to power reduction
- Make sure the ventilation of the installation spot, not sufficient ventilation may affect the operating performance of the electronic components inside the inverter and the life span of the inverter might be jeopardized



5.3 Safety Clearance

To make sure the ventilation of the installation spot, if there are multiple Mac solar inverters installed in the same area, the following safety clearance shall be followed for proper ventilation conditions.

Direction	Minimum Clearance
Above	30 cm
Below	50 cm
Side	30 cm
Front	5 cm

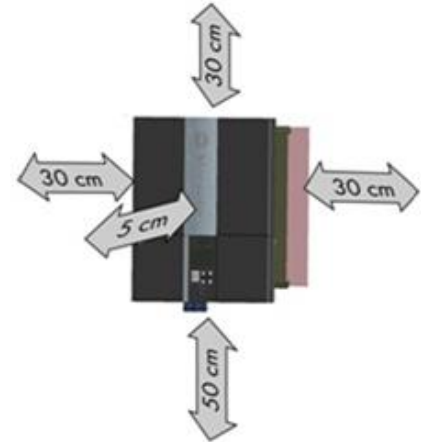



5.4 Mounting Procedure

1. Use the rear panel in the package as a drilling template and mark the positions of holes to be drilled (A/B/C/D1 or D2/E). Depending on the dimension of the wall, you have the free choice to mark position D1 or D2 for hole drilling.

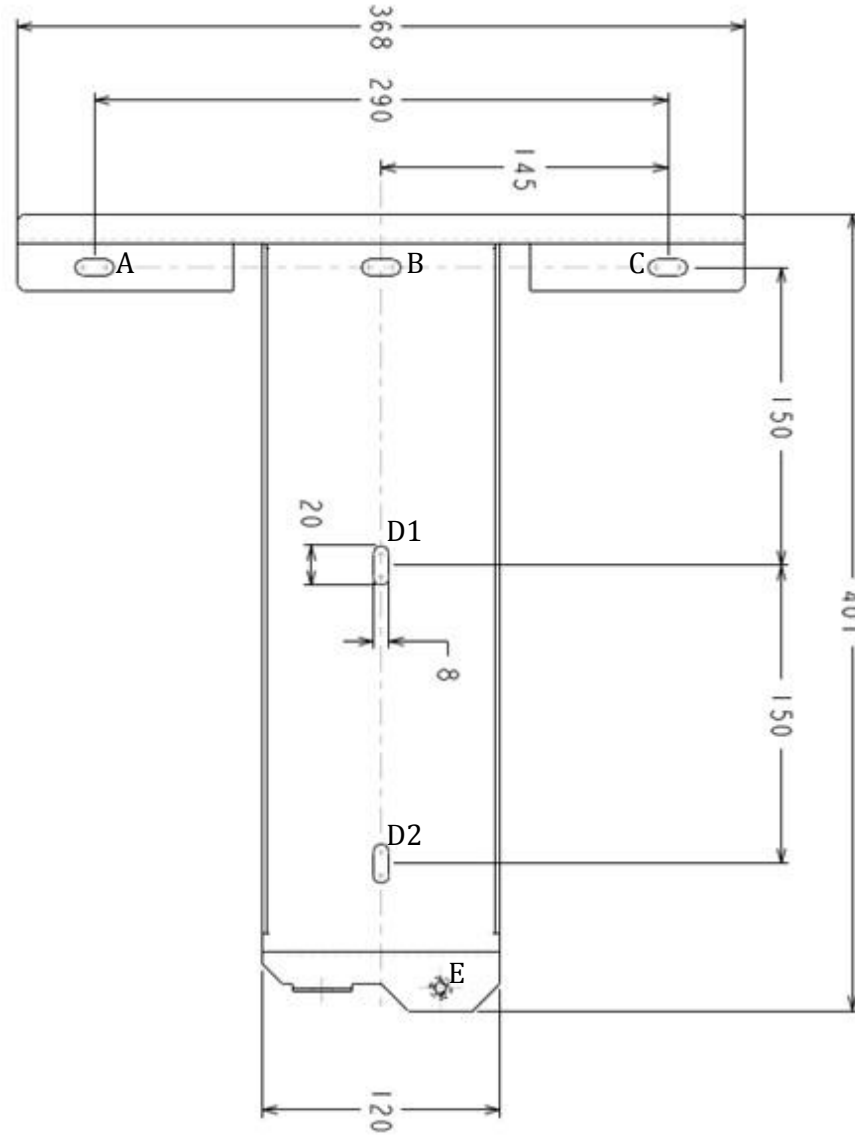



2. According to the marks, drill 4 holes (A/B/C/D1 or D2) in the wall, and then place four expansion tubes in the holes using a rubber hammer.

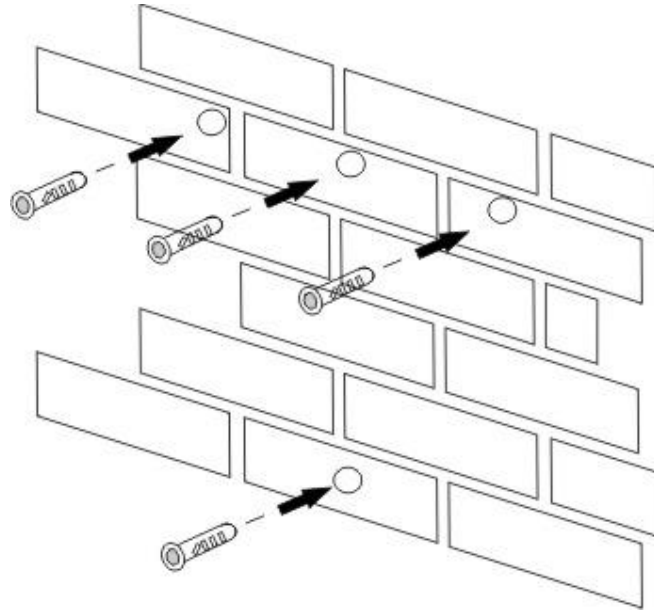

3. Mount the rear panel.
Wring four screws into the expansion tubes and tightly mount the rear panel on the wall.

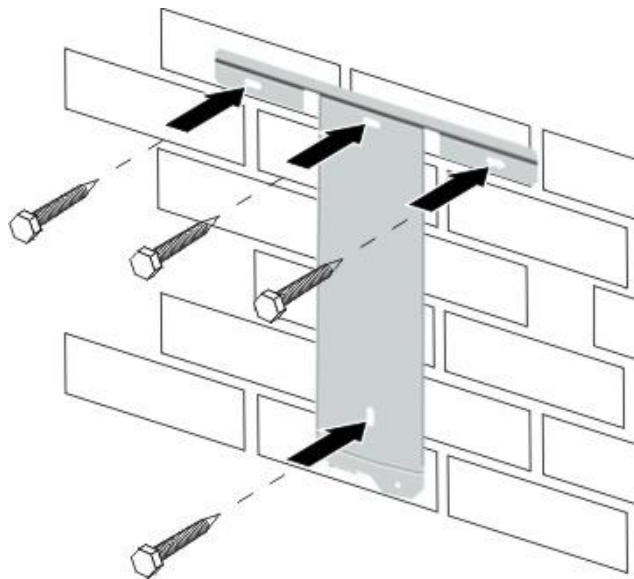



- Carefully attach the inverter to the rear panel according to the position of the screws. Make sure the backside of the inverter is closely against the rear panel.
 - When two people transport the inverter, make sure each one use the hand grip in right position as illustrated in the picture.

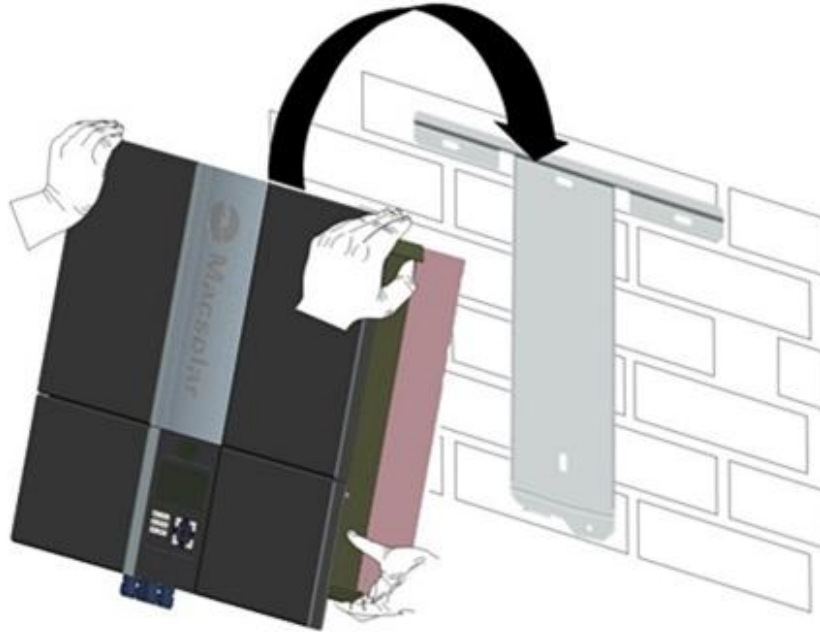

- When the inverter is tightly attached to the rear panel, wring the screw in position E.

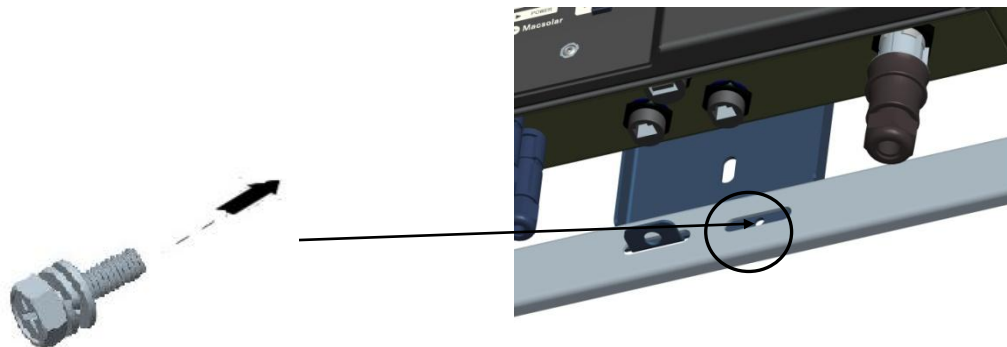

- Please carefully check the accessories and original carton to make sure during the installation every necessary part is used and nothing is missing.



5.5 Safety Lock

To prevent possible theft activity, Mac solar gives you an extra guard for your property. It is possible to lock the inverter to the rear panel with a padlock.

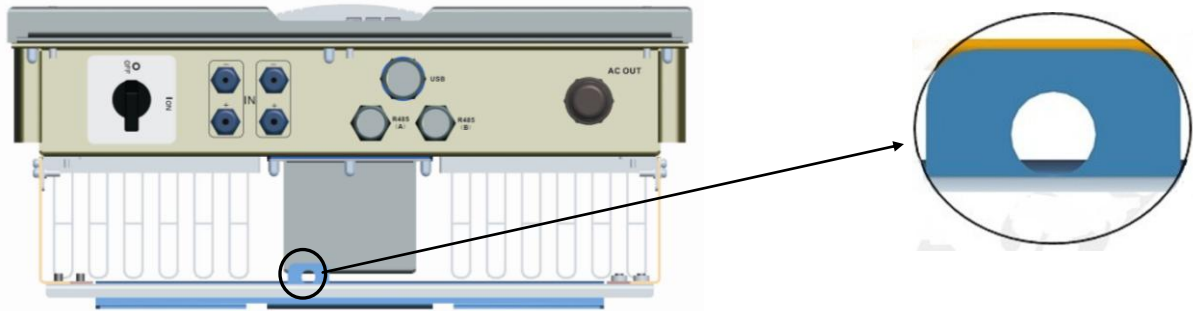

Recommended padlock dimension:

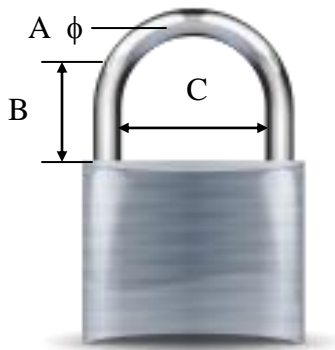

A. Shackle Diameter	6~9 mm
B. Vertical Clearance	8~15 mm
C. Horizontal Clearance	12~20 mm
Stainless, solid hanger and secured lock cylinder	



NOTICE

For further maintenance and possible repair, please keep the key of the padlock in a safe place.



After the inverter is attached to the rear panel, look at the bottom of the inverter, then the lock position will show as the following picture:

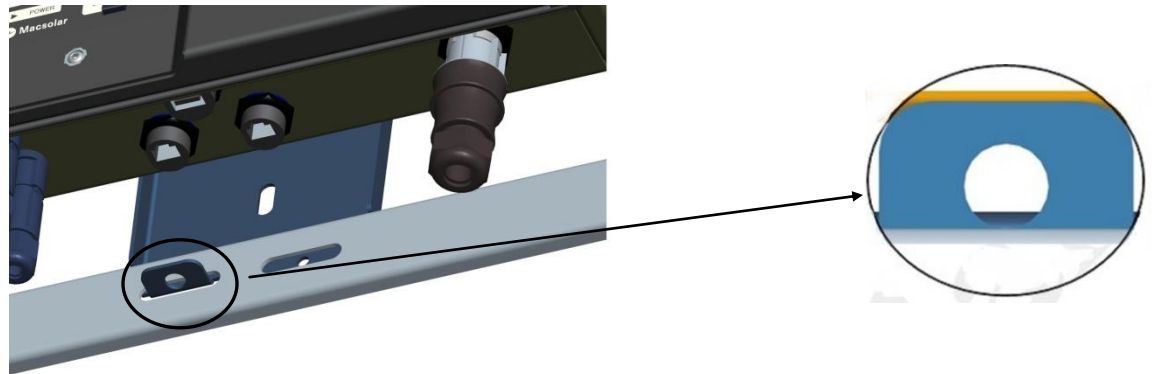



5.6 Check Varistors

If the one or more of the varistors might be out of function, please check or replace the varistors according to the following steps:

1. Loosen all 6 captive screws of the removable front lid. Right after the 6 captive screws are removed, please keep them at a distance. Lift the lid upwards and remove it.

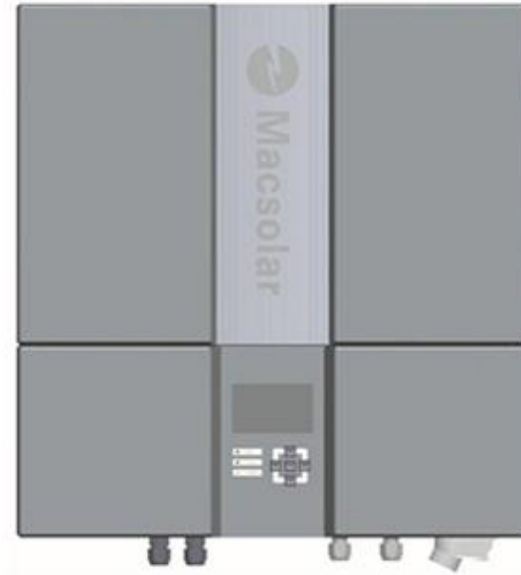

2. Then you will see the 5 varistors in 2 groups: 4 in the left side and 1 in the middle area.

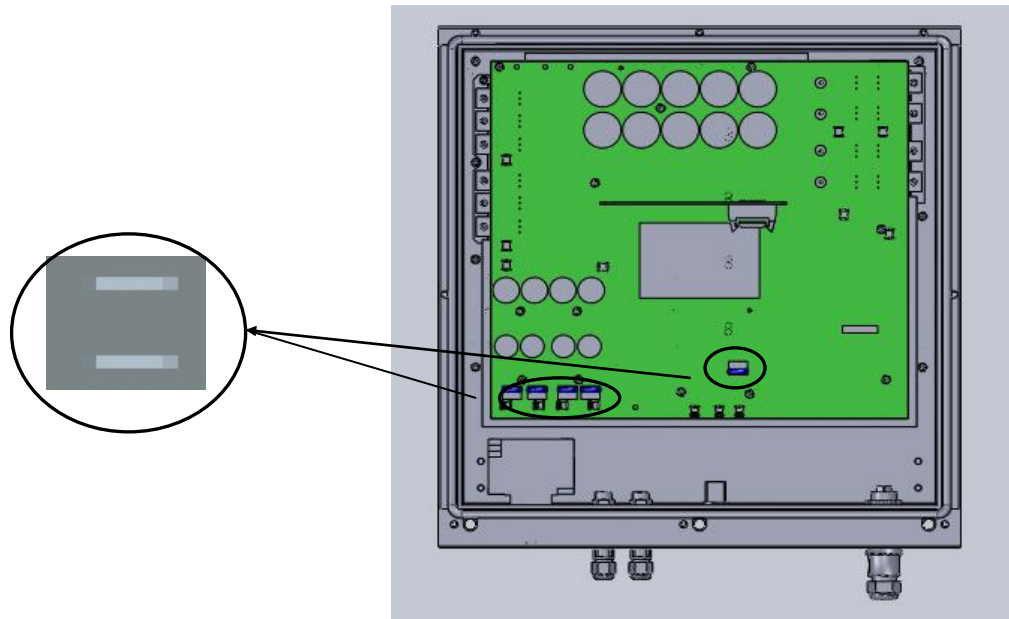

2 Remove and install the varistors

Remove:

First use specified tool and insert it to three holes in the left side of the varistor, then press it to the end.

Pull the varistor out.

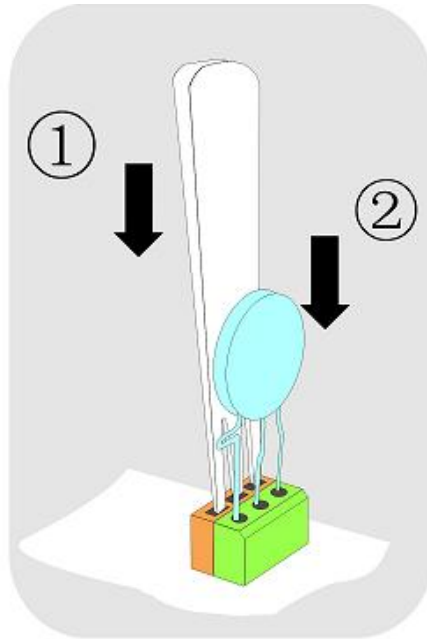
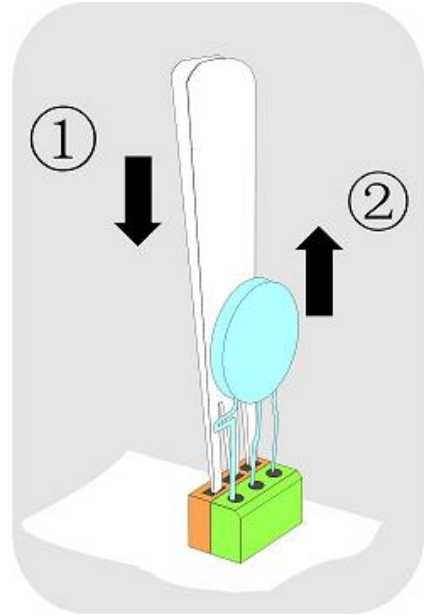

Install:

Use specified tool and insert it to three holes in the left side of the varistor, then press it to the end.

Press the varistor in.

3 Put the lid back and re-screw all 6 screws, make sure the lid is tighten to the inverter.



6. ELECTRICAL CONNECTION

6.1 Safety



DANGER

DANGER to life due to potential fire or electricity shock.

With the inverter powered, comply with all prevailing national regulations on accidents prevention.

This inverter will be directly connected with **HIGH VOLTAGE** power generation device, the installation must be performed by qualified personnel only in compliance with national and local standards and regulations.



NOTICE

Electrical connections shall be carried out in accordance with the applicable regulations, such as conductor sections, fuses, PE connection.

6.2 Overview of Connection Area

Bottom:

Single-input MPPT display picture

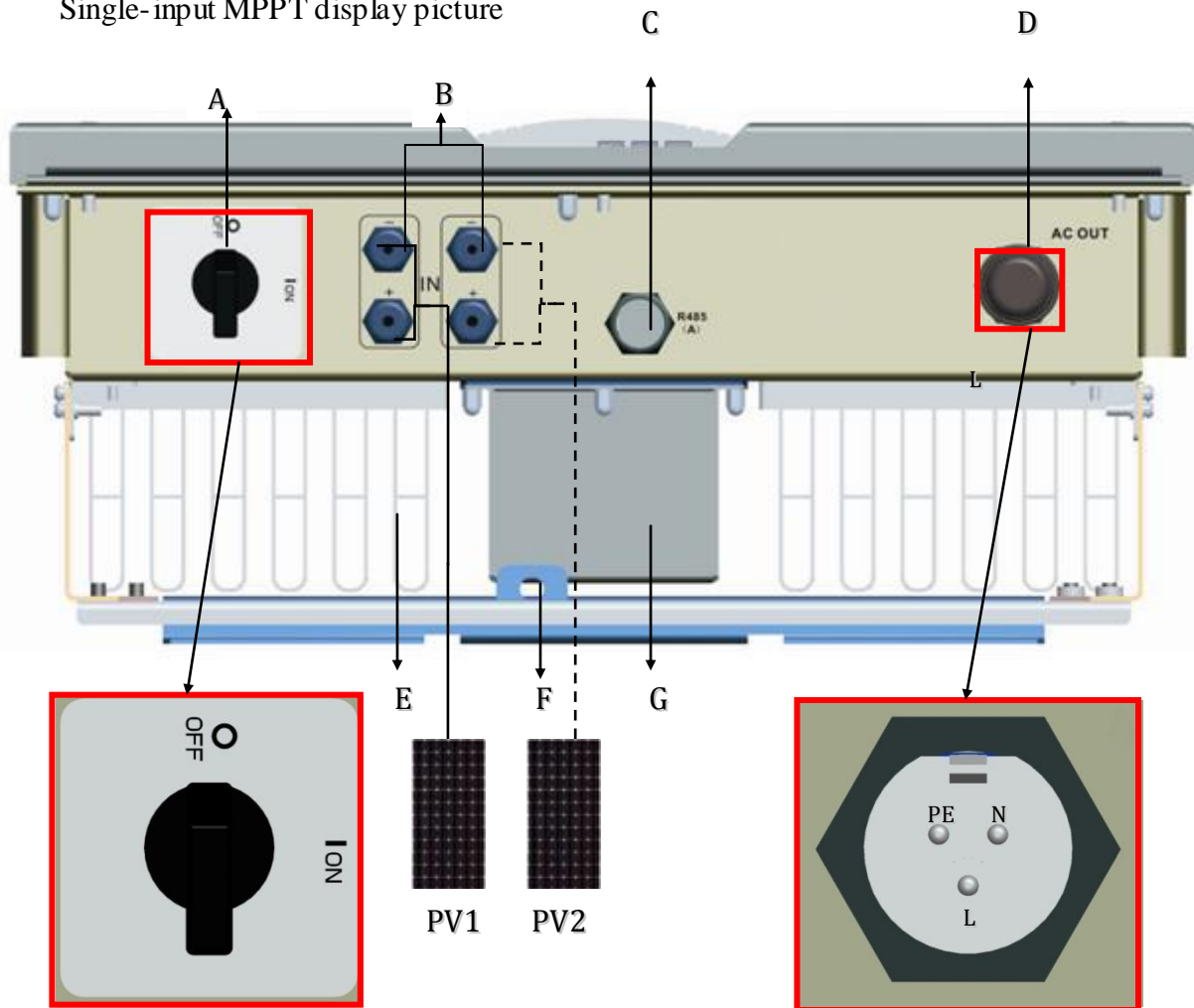

$I_{pv1} \cong$ Max. Input Current

$U_{pv1} \cong$ Absolute DC Voltage

Object	Description
A	DC switch to turn off the inverter manually
B	DC input, Anode connected with anode, cathode connected with cathode, the one route import electricity \leq inverter the biggest import electricity, the one route pressure and import pressure \leq inverter the biggest import pressure.
C	Plugs for connecting the RS485 communication module.
D	AC output (left-PE, right-N, down-L)
E	Heat sink
F	Extra lock
G	Inductor box

Dual-input MPPT display picture

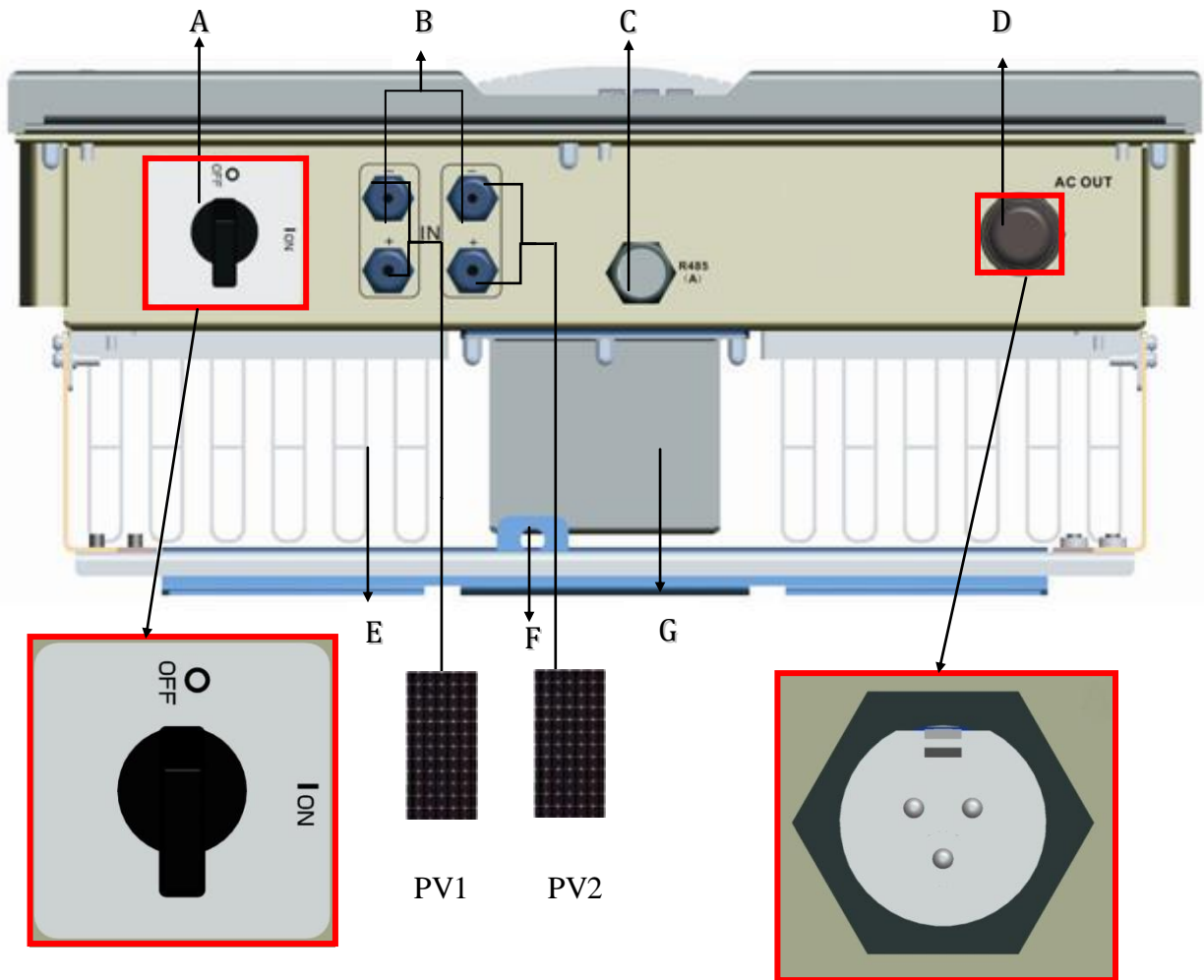

Connect method see 6.4

Dual-input MPPT independent connection

Object	Description
A	DC switch to turn off the inverter manually
B	DC input
C	Plugs for connecting the RS485 communication module.
D	AC output (left-PE, right-N, down-L)
E	Heat sink
F	Extra lock
G	Inductor box



6.3 AC Side Connection



DANGER

DANGER to life due to potential fire or electricity shock.

NEVER connect or disconnect the connectors under load.

Integrated RCD and RCM

The MacSolar inverter is equipped with integrated RCD (Residual Current Protective Device) and RCM (Residual Current Operated Monitor). The current sensor will detect the volume of the leakage current and compare it with the pre-set value. If the leakage current is above the permitted range, the RCD will disconnect the inverter from the AC load.

Assembly Instructions:

1. Strip the cable with the length 0.276 inches (9/32") - (7mm) and please be careful NOT to nick conductors.

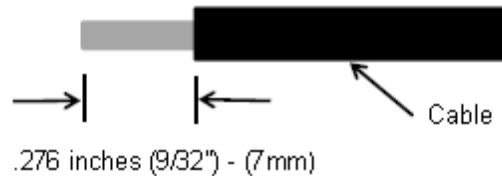

2. Screw off and separate each component of AC connector as follows.





3. Pass the cable through each component from left to the right as follows.

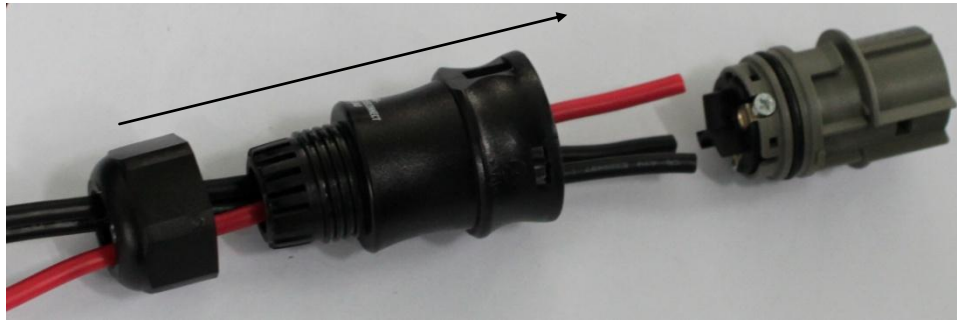

4. Use a screw driver and loose the three screws at the side of the straight plug. Then insert the stripped **N, L and PE cable accordingly** to the corresponding position and fully tighten the screws.



5. Aim the terminals on the straight plug to the holes of the grommet, and then compress them together. It is recommended to use the AC connection cable wrapping three stranded conductors (circled part in picture below), whose performance is qualified to pass the insulation as well as Hi-Pot tests.



6. Finally, connect the straight plug to the AC terminal on inverter. **Pay attention to the polarity of the terminals to avoid wrong connecting.**



7. The diameter of DC and AC cable should be featured with sufficient current-carrying capability.



6.4 DC Side Connection

Single-input MPPT independent connection

There is only one MPP Tracker (the second MPP Tracker is optional equipped), for the two string inputs, the connected PV modules must meet following requirements:

- Same type
- Same quantity
- Identical alignment
- Identical tilt
- $PV1_{electricity} + PV2_{electricity} \cong \text{inverter the biggest electricity}$
- $PV1_{pressure} = PV2_{pressure} \cong \text{inverter the biggest electricity}$

Dual-input MPPT independent connection

There are two MPP Trackers, thus each string input can connected with different type of PV modules as long as they meet following requirements

The inverter with dual-input MPPT configuration: the dual-input PV input terminals need to be connected with two-group independent PV strings respectively. The inverter can achieve the maximum output power.

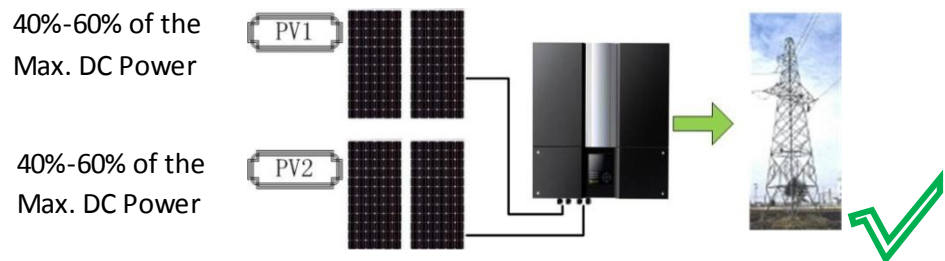

Dual-input MPPT paralleled connection:

The following three methods are not be permitted.

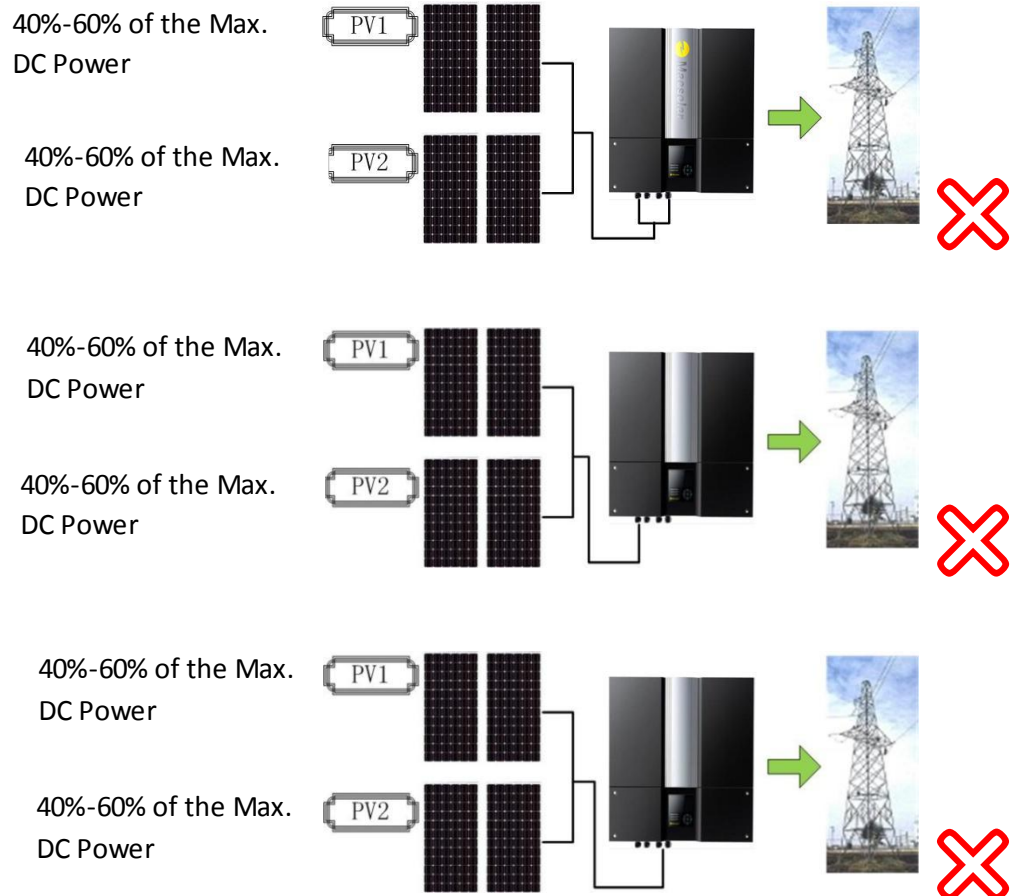

If inverter connects to PV strings use above method, you may face the following risks:

- Inverter maybe cannot output the maximum power.
- The lifetime of the inverter maybe decrease.
- The manufacture shall not be liable for consequences of any inexpert connection method or alterations.



Inverter Type	MPP Tracker	Max. DC Power	Max. DC Voltage	Max. DC Current
Macsol-TL3K	1(Standard) /2(Optional)	3400W	580V	21A
Macsol-TL3.6K		4100W		21A
Macsol-TL4K		4550W		21A
Macsol-TL5K	2	5650W		28A



DANGER

DANGER to life due to potential fire or electricity shock.

NEVER connect or disconnect the connectors under load.



NOTICE

If only one string input is used for DC connection, please use the sealing plug to seal the left DC input set to ensure the inverter IP 65 protection.



The DC connectors come pre-assembled and the caps are loose. The whole connector will include the male side and female side as showed below:



Female side connector (F)



Male side connector (M)

Assembly Instructions:

1. Strip the cable with the length 0.276 inches (9/32") - (7mm) and please be careful NOT to nick conductors.

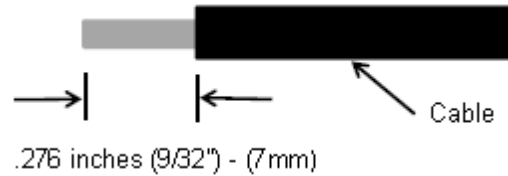

Use specified strip tool in this step. Adjust the stripper stopper and put the cable in corresponding notch to strip the length of 7mm. Please see below figures.





2. Insert striped cable into contact barrel and insure all conductor strands are captured in the contact barrel and the conductors are visible in the contact barrel observation hole. Please see below figures.

Pin contact



Barrel observation hole
Conductor should be visible

Socket contact



Barrel observation hole
Conductor should be visible

3. Crimp contact barrel by using the hex crimping die. Please see below figures.

Crimped pin contact



Crimped socket contact





4. Insert contact cable assembly into back of male and female connector. A “click” should be heard or felt when the contact cable assembly is seated correctly. Please see below figures.



Female side connector (F)



Male side connector (F)





5. Wrest the cap by using the torque of 2.6~2.9NM.



6. After wrest the cap tightly, align the 2 half connectors and mate them together by hand until a “click” is heard or felt.

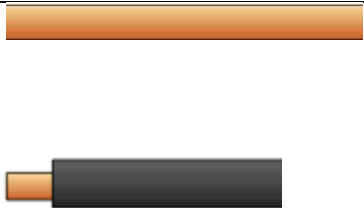

6.5 DC Side Adapter plug & Cable requirements

Des	specification/style	Pic
2Adapter plug	PV-130510-000 Degree of protection: IP 68 Ambient temperature range:-40°C...+90°C	
2Adapter socket	PV-130510-000 Degree of protection: IP 68 Ambient temperature range:-40°C...+90°C	
Cable requirements	Contact Size :6mm ² /10AWG Rated current :52A,Rated voltage:1000V Socket contact material: Copper, Tin plated Contact resistance 0.25mΩ TYP. Strip length7mm	
Cable jacket	Cable jacket Diameter:4.5~7.5mm	



NOTICE

Please use the machine attached terminal to connect with the machine.



6.6 DC Side Disconnection

When the separation of DC connectors is necessary, please use the specified tool (Ring tool or wrench tool) to separate them.

While using the ring tool or wrench tool, please make sure the wedge side of the fingers faces the female connector and push the tool down. Then separate the connector by hand. See below figures.

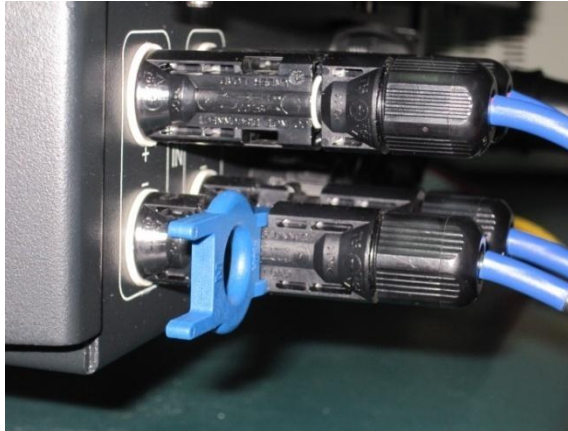

Separation by ring tool

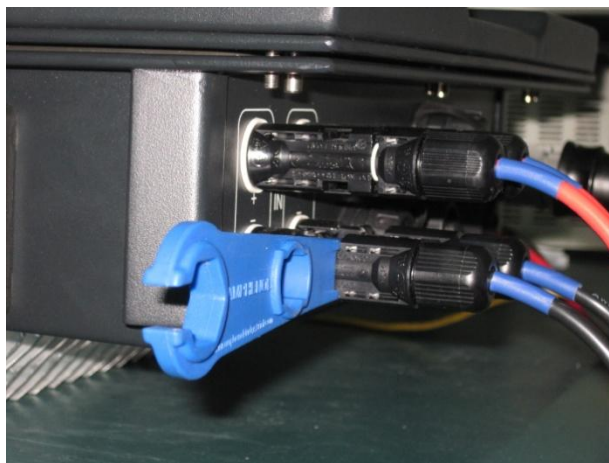

Separation by wrench tool



6.7 Communication and Monitoring Device

There are 1 plug in the bottom side of the Macsolar inverter:



1 × RS485---COM1 (**using for connect with the inverters**)

All communication and monitoring plugs in Macsolar inverter are simply “plug and use”.

Please select the appropriate one according to the desired functionality and usage.

7. CONFIGURATION

7.1 LCD Display

Front:

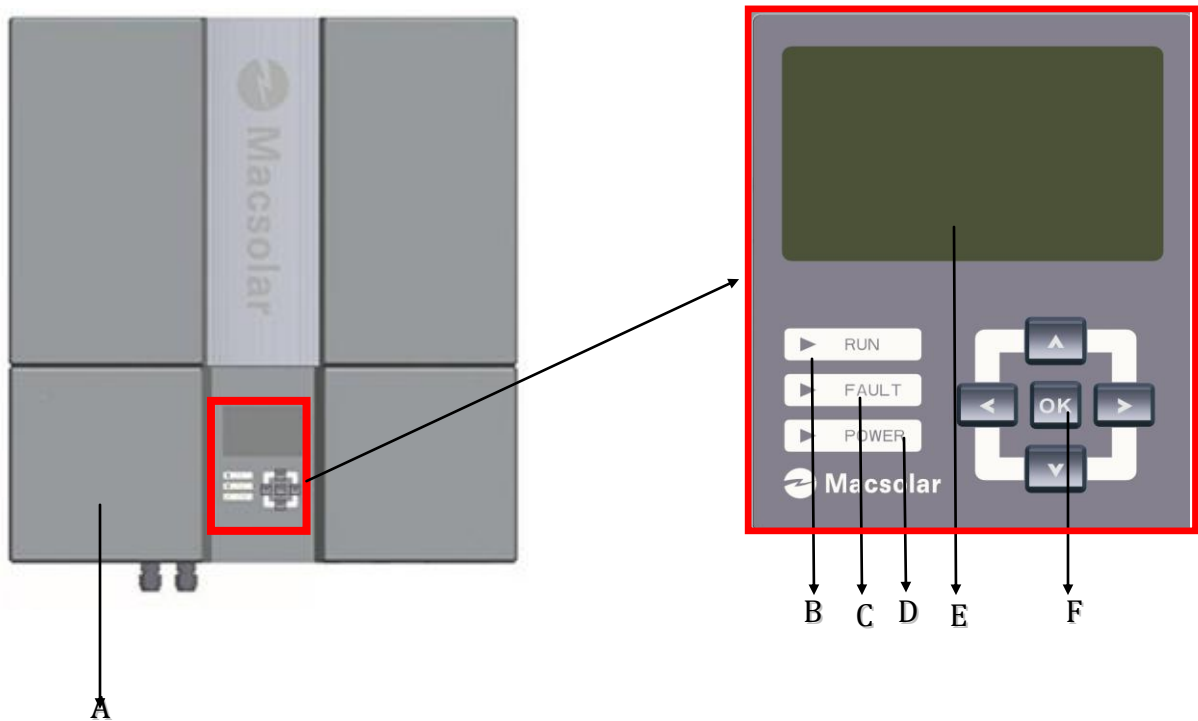

Object	Description
A	Removable front lid for potential maintenance and repair
B	LED light-RUN
C	LED light-FAULT
D	LED light-POWER
E	LCD screen for checking the operating status and configuration
F	Control keyboard for displays and configuration of parameters



Press any key from the control keyboard to illuminate the LCD screen.

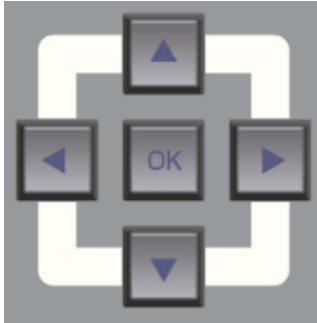

Item	Function
	“Right” key Depending on the selection: To navigate right To navigate to the next level menu
	“Down” key Depending on the selection: To navigate down Change to the next number
	“Left” key Depending on the selection: To navigate left To navigate to the previous level menu
	“Up” key Depending on the selection: To navigate up Change to the previous number
	“OK” key Depending on the selection: To confirm a selection To enter the main menu



NOTICE

Mac solar inverter is not an aligned measuring instrument for current, voltage or power consumption. A slight deviation of a few percent points is intrinsic to the system, the results from the inverter cannot be used for grid balance calculations. An aligned meter will be required to make calculations for the utility company.

7.2 Setup

Illustration for reference only, please subject to real sample in case of any discrepancy



NOTICE

Make sure the DC switch shall switch to “Open”, otherwise Macsolar inverter cannot work due to power shortage.

DISPLAY

After the inverter has started, programs will be initialized with the screen showing as follows;

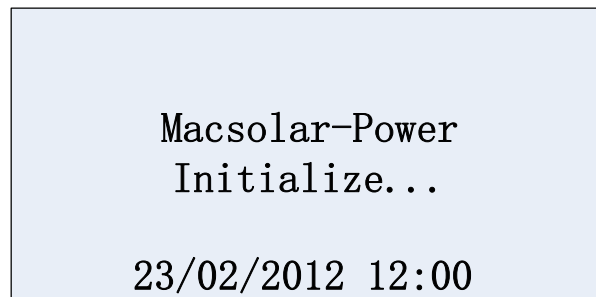

Once fault occurs, Inverter shall display error as shown in below figure, please refer to 7.3 for different error codes. If fault cleared, error display shall disappear immediately while recent 30 fault events shall be recorded.

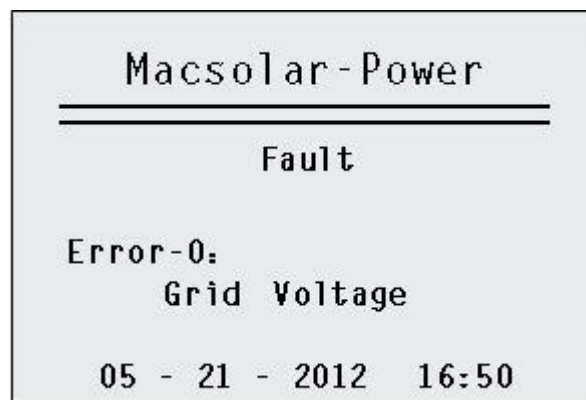

<u>MacSolar - Power</u>	
Energy	Today : 0.57kWh
Inst.	Power : 1250W
05 - 21 - 2012 14:50	

When Inverter get booted normally, it shall display data as following: Daily generated power, Current inverter power, Total generated power and Total time endurance. Current date and time shall be displayed at the bottom.

<u>MacSolar - Power</u>	
Total	Energy 10.48kWh
Running	Time 9.72 hour
05 - 21 - 2012 14:50	

After reviewing all information relevant to the system, you are able to enter the main menu by pressing the “OK” button on display panel and acquire any parameter concerning the product which interests you, such as fault info, configuration, language, device info.etc.

<u>MacSolar - Power</u>
Fault Info.
Configuration
Language
Device Info.



Fault info.

Press “Left” key to exit from the submenu and back to main menu. Press the “down” key to select the “Fault Info.” option with “OK” for confirmation. You are able to check all record information generated at different moments during the running of inverter. The complete record information including Record code, and definition are summarized in section 7.3. You can also learn about the specific record description according to the corresponding event No. by referring to chapter 7.4 “Further information for the event record”.

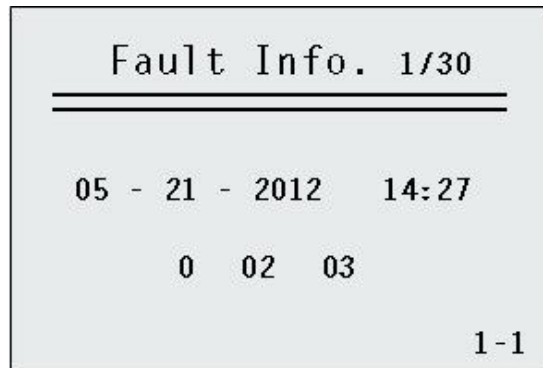

Configuration

Press “Left” button to exit from the submenu and back to main menu. Press the “down” key to select the “Configuration” option with “OK” for confirmation. Subsequently, you are eligible to set up the “Date/Time”, “Address”, through manipulation of “up” and “down” button.

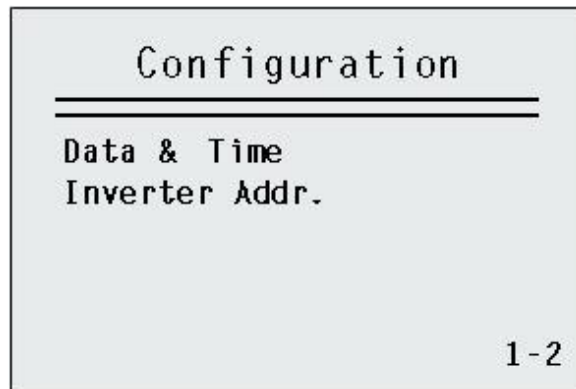

“Date/Time” Setup:

Use “Up/Down” key to set the number and confirm the settings by “OK” button;

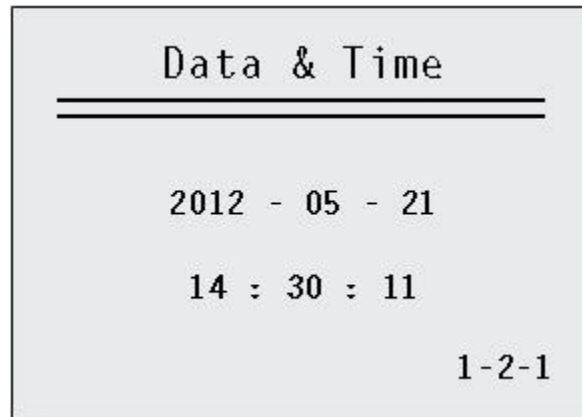

“Address” Setup:

Use “Up/Down” key to set the number and confirm the settings by “OK” button;



NOTICE

Possible communication failure due to wrong configuration

Selection of the inverter’s address will directly affect the performance of the data logger.

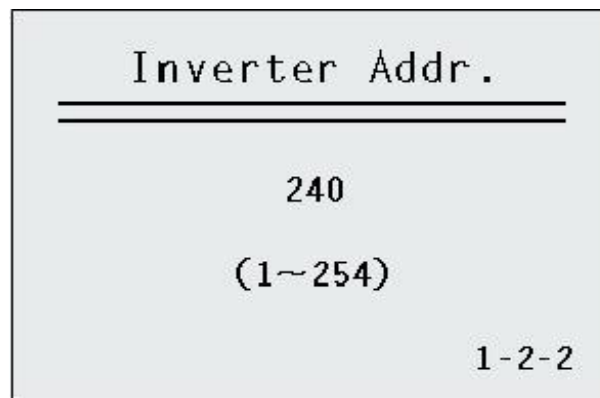

“



Language



Device info.

Press “Left” key to exit from the submenu and back to main menu. Press the “down” key to select the “Device Info.” option with “OK” for confirmation. Then you can get access to system information involving control software, ARM software, serial number, machine type and safety type.

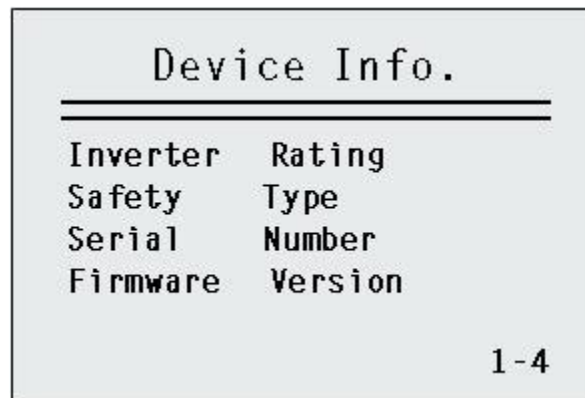

Inverter Rating

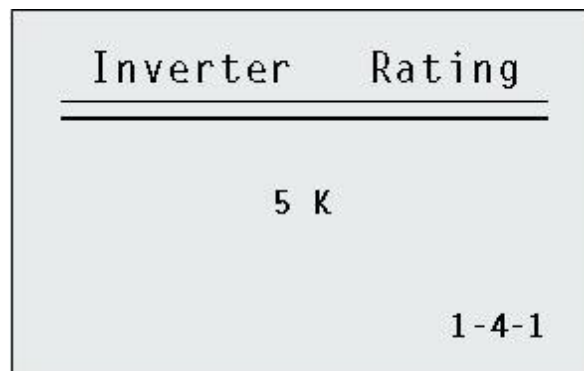



Safety Type

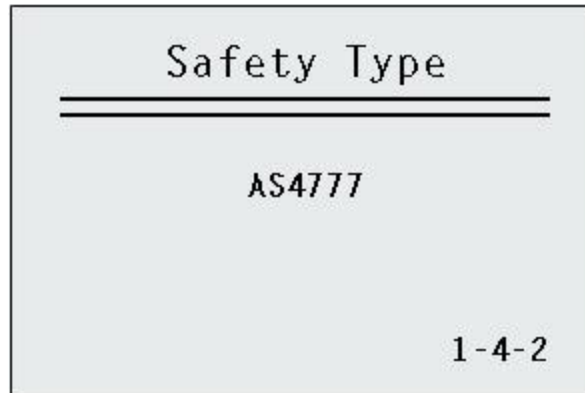

Serial Number

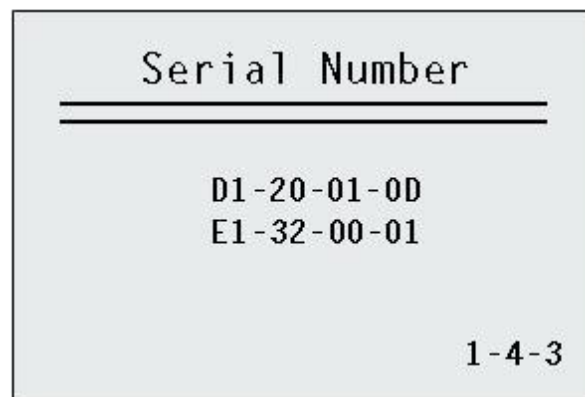

Firmware Version

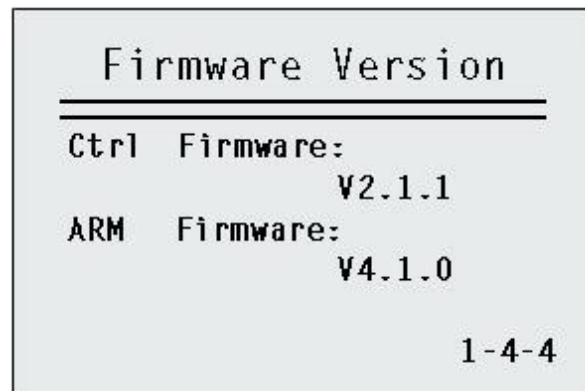

7.3 Event number table

If any of the following messages occurs in LCD Screen, or the status LED Light “Fault” is on, there is one or more event that has been detected by Mac solar Inverter.

Event NO.	Information
0	Grid Voltage Fault
01	Grid Overvoltage.10min Fault
02	Grid Frequency Fault
03	Grid Voltage Loss
04	DC Bus Overvoltage
05	GFCI Fault
06	Inverter Overheat
07	Varistor Fault
08	PV Overvoltage
09	Consistence Fault
10	Isolation Fault
11	DC Injection Fault
12	Device Fault
13	GFCI Device Fault
14	Comm. Disturbed
15	Current Sensor Fault
16	CPU Ref 2.5V Fault
17	EEPROM R/W Fault
18	DC Injection Device Fault
19	Relay Fault
20	AC Over Current
21	ARM-Ctrl Comm

7.4 Further information for the event record

Table 1
Record originated from inverter fault

Event No.	Message and course	Corrective measures
10	<p>“Isolation Fault”</p> <p>The isolation resistance between the DC side to earth is too low.</p> <p>Following conditions might lead to this error:</p> <ul style="list-style-type: none"> – The isolation of the PV panel is not so good. – Internal fault of the inverter. <p>The inverter will not feed power to the grid when this event occurs.</p>	<ul style="list-style-type: none"> – Check the isolation of the PV panel. <p>If this event occurs continuously and the inverter doesn’t work:</p> <ul style="list-style-type: none"> – Please contact your franchiser.
12	<p>“Device Fault”</p> <p>A fault has occurred in one or more major components of the inverter.</p> <p>For safety consideration, the inverter will shutdown.</p>	<p>If this event occurs:</p> <ul style="list-style-type: none"> – If alarm frequently and the machine cannot work, please write the feedback information form, connect with supplier.
13	<p>“GFCI Device Fault”</p> <p>A fault has occurred to the GFCI detecting circuit.</p> <p>For safety consideration, the inverter will shut down.</p>	<p>If this event occurs:</p> <ul style="list-style-type: none"> – If alarm frequently and the machine cannot work, please write the feedback information form, connect with supplier.
14	<p>“Comm. Disturbed”</p> <p>A fault has occurred in the internal communication of the inverter.</p> <p>For safety consideration, the inverter will shut down.</p>	<p>If this event occurs:</p> <ul style="list-style-type: none"> – If alarm frequently and the machine cannot work, please write the feedback information form, connect with supplier.



15	<p>“Current Sensor Fault”</p> <p>A fault has occurred in one or more current sensor of the inverter.</p> <p>For safety consideration, the inverter will shut down itself.</p>	<p>If this event occurs:</p> <ul style="list-style-type: none"> – If alarm frequently and the machine cannot work, please write the feedback information form, connect with supplier.
16	<p>“CPU Ref2.5V Fault”</p> <p>The CPU voltage that detected by internal sensor is deviating the pre-set 2.5V reference line.</p>	<p>If this event occurs:</p> <ul style="list-style-type: none"> – If alarm frequently and the machine cannot work, please write the feedback information form, connect with supplier.
17	<p>“EEPROM R/W Fault”</p> <p>Internal device fault.</p> <p>For safety consideration, the inverter will shut down.</p>	<p>If this event occurs:</p> <ul style="list-style-type: none"> – If alarm frequently and the machine cannot work, please write the feedback information form, connect with supplier.
18	<p>“DC Injection Device Fault”</p> <p>A fault has occurred to the DC current inject detecting circuit.</p> <p>For safety consideration, the inverter will shut down.</p>	<p>If this event occurs:</p> <ul style="list-style-type: none"> – If alarm frequently and the machine cannot work, please write the feedback information form, connect with supplier.
19	<p>“Relay Fault”</p> <p>A fault has occurred to the grid-connecting relay.</p> <p>For safety consideration, the inverter will shut down.</p>	<ul style="list-style-type: none"> – Please disconnect the DC input then reconnect after a short while. <p>If this event occurs continuously and the inverter doesn’t work:</p> <ul style="list-style-type: none"> – Please contact your franchiser.

Table 2
Other record

Event No.	Message and course	Corrective measures
0	<p>“Grid Voltage Fault”</p> <p>The grid voltage has exceeded the permitted range according to local grid regulations.</p> <p>Following conditions might lead to this error:</p> <ul style="list-style-type: none"> – Grid voltage is out of the range rating. – Sudden change to the grid. – Grid impedance at the terminal of the inverter is too high. <p>For safety consideration, the inverter will disconnect from the grid for a short time till the grid return to normal.</p>	<ul style="list-style-type: none"> – Check the grid voltage. <p>If this event occurs continuously and the inverter doesn’t work:</p> <ul style="list-style-type: none"> – Please contact your franchiser.
01	<p>“Grid Over voltage 10min Fault”</p> <p>The average grid voltage in 10 minutes has exceeded the permitted range according to local grid regulations.</p> <p>Following condition might lead to this error:</p> <ul style="list-style-type: none"> – Grid voltage is too high. <p>For safety consideration, the inverter will disconnect from the grid for a short time till the grid return to normal.</p>	<ul style="list-style-type: none"> – Check the grid voltage. <p>If this event occurs continuously and the inverter doesn’t work:</p> <ul style="list-style-type: none"> – Please contact your franchiser.
02	<p>“Grid Frequency Fault”</p> <p>The grid voltage has exceeded the permitted range according to local grid regulations.</p> <p>Following conditions might lead to this error:</p> <ul style="list-style-type: none"> – Grid frequency is out of the range rating. – Sudden change to the grid. – Incorrect safety guide setting. <p>For safety consideration, the inverter will</p>	<p>If this event occurs continuously and the inverter doesn’t work:</p> <ul style="list-style-type: none"> – Please contact your franchiser.



	disconnect from the grid for a short time till the grid return to normal.	
03	<p>“Grid Voltage Loss”</p> <p>The inverter has detected an error in the cabling and cannot connect to the grid.</p> <p>Following conditions might lead to this error:</p> <ul style="list-style-type: none"> - Network connection installation is inappropriate. - Cabling inappropriate. - Grid power-off. - AC output fuse open. <p>Event 0 and event 2 may be reported additionally.</p>	<ul style="list-style-type: none"> - Check AC installation. - Check network connection. - Check fuse. <p>If this event occurs continuously and the inverter doesn't work:</p> <ul style="list-style-type: none"> - Please contact your franchiser.
04	<p>“DC Bus Over voltage”</p> <p>The voltage of the DC Bus is too high.</p> <p>Following conditions might lead to this error:</p> <ul style="list-style-type: none"> - The input voltage of the PV string is too high. - The DC to DC function is out of control. <p>For safety consideration, the inverter will disconnects itself from the grid.</p>	<ul style="list-style-type: none"> - Please immediately disconnect the inverter from the PV strings (see chapter 6.5 “DC side Disconnection”). - Measure the DC voltage of the strings to find out whether the value is in the range of specified DC voltage from datasheet. If the voltage is still too high, please make consultation with the system installer. Otherwise, please contact your franchiser.
05	<p>“GFCI Fault”</p> <p>The inverter has detected a ground fault in the PV system.</p>	<ul style="list-style-type: none"> - Please refer to the PV system installer to renovate the ground fault. <p>If this event occurs continuously and the inverter doesn't work:</p> <ul style="list-style-type: none"> - Please contact your

		franchiser.
06	<p>“Inverter Over heat”</p> <p>The temperature of the heat sink is too high.</p> <p>Following conditions might lead to this error:</p> <ul style="list-style-type: none"> – Sensor of the temperature defective. – Overheating inside. – Not sufficient ventilation. <p>For safety consideration, the inverter will disconnect from the grid until the temperature return to normal.</p>	<ul style="list-style-type: none"> – Please ensure sufficient ventilation. <p>If this event occurs continuously and the inverter doesn’t work:</p> <ul style="list-style-type: none"> – Please contact your franchiser.
07	<p>“Varistor Fault”</p> <p>The varistor on the DC side is defected.</p> <p>Following conditions might lead to this error:</p> <ul style="list-style-type: none"> – Varistor is burst due to high voltage surge such as thunder lightning. – Varistor is ageing invalid 	<p>If this event occurs:</p> <ul style="list-style-type: none"> – Please check the varistors as chapter 5.6 “Check Varistors”. <p>If this error is not solvable:</p> <ul style="list-style-type: none"> – please contact your franchiser.
08	<p>“PV Over voltage”</p> <p>The DC input voltage which connects to the inverter is too high.</p> <p>Following conditions might lead to this error:</p> <ul style="list-style-type: none"> – The open-circuit voltage of the PV generator is higher than the maximum DC input voltage of the inverter. – Sudden DC surge. – Junction temperature of solar panel too low. <p>Event 8 may be reported additionally.</p>	<ul style="list-style-type: none"> – Please immediately disconnect the inverter from the PV strings (see chapter 6.5 “DC side Disconnection”). – Check the DC voltage of the strings for adherence to the maximum input voltage of the inverter, before you reconnect the inverter to the PV strings.
09	<p>“Consistence Fault”</p> <p>Internal fault has occurred for the inverter.</p>	<p>If this event occurs continuously and the inverter doesn’t work:</p> <ul style="list-style-type: none"> – Please contact your franchiser.

11	<p>“DC Injection Fault”</p> <p>The direct current injecting to the grid exceeds the permitted range.</p> <p>Following conditions might lead to this error:</p> <ul style="list-style-type: none"> – Sudden input power change due to cloud. – Internal fault of the inverter. 	<p>If this event occurs continuously and the inverter doesn't work:</p> <ul style="list-style-type: none"> – Please contact your franchiser.
20	<p>“AC Over Current”</p> <p>The detected AC current has exceeded the pre-set Max. AC Current.</p> <p>Following causes might lead to this error:</p> <ul style="list-style-type: none"> – Short circuit happens in the grid. 	<ul style="list-style-type: none"> – Check the AC network to find out the short circuit, then restart the inverter manually. <p>If this event occurs continuously and the inverter doesn't work:</p> <ul style="list-style-type: none"> – Please contact your franchiser.
21	<p>“ARM-Ctrl Comm”</p> <p>because no communication between ARM board and Control board so the fault keeping exist</p> <p>Following causes might lead to this error:</p> <ul style="list-style-type: none"> – board fall off with control board 	<p>If this event occurs continuously and the inverter doesn't work:</p> <ul style="list-style-type: none"> – Please contact your franchiser.

Table 3
Explanation of fault grades

Fault grades	Description	Power (Green LED)	Run (Yellow LED)	Fault (Red LED)	Event No.
A	Inverter is stopped due to equipment fault.	On	Off	On	10,12,13,14,15,16,17,18,19,21
B	Inverter is stopped due to restorable faults and environment faults.	On	Off	Flash (1Hz)	0,01,02,03,04,05,06,08,09,11,20
C	voltage dependent resistor fault	On	On	Flash (1Hz)	07



8. RECYCLING AND DISPOSAL



WARNING



This device SHALL NOT be disposed of in residential waste.

To comply with European Directive 2002/96/EC on waste Electrical and Electronic Equipment and its implementation as national law, electrical equipment that has reached the end of its life must be collected separately and returned to an approved recycling facility. Any device that you no longer required must be returned to your dealer or you must find an approved collection and recycling facility in your area.

Ignoring this EU Directive may have severe effects on the environment and your health.



9. GUARANTY SCOPE AND GUARANTY SERVICE

9.1 MacSolar Factory Guaranty Scope

This guaranty declaration is solely applied to the following MacSolar Grid-Tied Solar Inverter:

- Macsol-TL3K
- Macsol-TL3.6K
- Macsol-TL4K
- Macsol-TL5K

For the above named products, you will receive a MacSolar factory warranty card which will valid for 5 years from the date of purchase. The MacSolar factory warranty covers any costs which you incur for repair or replacement parts during the agreed period beginning at the date of purchase of the device, subject to the conditions listed below. This is not associated with a durability warranty.

You have the possibility of purchasing an extension of this MacSolar factory warranty within the 5 year term of the MacSolar factory warranty. The prices are based on the respective MacSolar price list valid at the time the warranty extension was signed.

9.2 Guaranty Conditions

This guaranty declaration is solely applied when any defect of MacSolar inverter is detected.

If a device becomes defective during the MacSolar guaranty period, and it is proved that further functional performance is impossible, the device will be, as selected by MacSolar:

- Repair the defect at the factory free of charge within the guaranty period.
- Exchange for a replacement device of equivalent value according to model and age.

If it is the latter case, the remainder of the warranty entitlement will be automatically transferred to the replacement device. In this case, you will not receive a new certificate since your entitlement is already documented at MacSolar.



NOTICE

If exchange for a replacement device of equivalent value according to model and age is needed. The defected unit must, where possible, be returned in its original or equivalent packaging.

MacSolar will only perform guaranty service only if the user provides a copy of invoice which was issued to the user by the dealer and a completed warranty card. If any one of these two is missing, MacSolar has the rights to deny the guaranty service or only provide paid service.

9.3 Guaranty Exclusion

Guaranty declaration is excluded in the following cases:

- Transport damage
- Improper installation and installation that does not comply with standards
- Use of the devices in ways not intended
- Improper operations without following the user manual
- Operation of units with defective protective equipment which might lead to damage
- Unauthorized modifications to the units or repair attempts
- Influence of foreign objects and force majeure (lightning, grid overvoltage, severe weather, fire)
- Insufficient ventilation of the unit
- Failure to observe the relevant safety regulations

If the device becomes defective when in any of the above cases, MacSolar will not perform guaranty service and the user shall take whole responsibility for the defects.



10. CONTACT

Shanghai Headquarter

Level 4, 7/836 Shengli Road , Pudong ,CN-201201 , Shanghai. P.R. China

Tel: (+86)-21-50720885 / (+86)-21-68689998

Fax: (+86)-21-50720639

Email: info@macsolar-power.com

www.macsolar-power.com

Service line

Tel: (+86)-21-50720885 / (+86)-21-68689998

Fax: (+86)-21-50720639

Email: service@macsolar-power.com

www.macsolar-power.com

11. SYSTEM COMMISSIONING CONFIRMATION REPORT

This report confirms successful commissioning of a Photovoltaic-Inverter System connected to the public electricity distribution network.

One Commissioning Sheet per installation is to be returned to the Authorized Distributor to activate any and all inverter warranty. Failure to return this Commissioning Report may void all inverter warranty.

Site Details

Address of Installation:	
No;	
Street:	
Town:	
State:	
Post Code:	
Address Telephone Number:	
Distribution Network Operator:	

Contact Details

Inverter Owner:	
Contact Person:	
Contact Telephone Number:	
Contact E-mail Address:	

MacSolar Inverter Details

Inverter Model:		
Inverter Serial Number:		
Software Version Numbers:	(a)Control Software:	
	(b)Display Software:	
Inverter Rating(kW):		
Number of Inverter MPPT Inputs:		
Location of Inverter Within Installation:	Place a × in the appropriate box 	×
	Outside Under Array	
	Outside Exposed to Weather	
	Outside Under Cover	
	Inside Building	
	Other	
Location of dc array isolator:		

Installed Photovoltaic Modules

	Array String	1	2	3	4
	Number Of Modules/String				
String 1 Module Details					
MPPT Input:	✓ the MPPT number	1	2		
Module Brand and Type:					
Module Nominal Power (Wp) :					
Voc @ 25Deg.C(V dc):					
Isc @ 25Deg.C(A dc):					
Max Power @ 25Deg.C(W):					
No. of Cells in module:					
String 2 Module Details					
MPPT Input:	✓ the MPPT number	1	2		
Module Brand and Type:					
Module Nominal Power (Wp) :					
Voc @ 25Deg.C(V dc):					
Isc @ 25Deg.C(A dc):					
Max Power @ 25Deg.C(W):					
No. of Cells in module:					
String 3 Module Details					
MPPT Input:	✓ the MPPT number	1	2		
Module Brand and Type:					
Module Nominal Power (Wp) :					
Voc @ 25Deg.C(V dc):					
Isc @ 25Deg.C(A dc):					
Max Power @ 25Deg.C(W):					
No. of Cells in module:					
String 4 Module Details					
MPPT Input:	✓ the MPPT number	1	2		
Module Brand and Type:					
Module Nominal Power (Wp) :					
Voc @ 25Deg.C(V dc):					
Isc @ 25Deg.C(A dc):					
Max Power @ 25Deg.C(W):					
No. of Cells in module:					
		String1	String2	String3	String4
String Test:					
Voc (V):					
Isc (A):					
Sun Intensity When Measured:	High		Medium		Low



Wiring and Connection to Grid

Protective Device (dc Side):					
Type:					
Rating (A dc):					
Rating (V dc):					
Capacity (kA dc):					
Array Wiring:		mm ²			
Earth:		mm ²			
Polarity and Insulation					
Array Insulation Test Voltage:		V dc			
Positive Earth (MΩ):					
Negative Earth (MΩ):					
Protective Device (ac Side):					
Type:					
Rating (A ac):					
Rating (V ac):					
Capacity (kA ac):					
AC wiring:		mm ²			
Earth:		mm ²			



PV System – Installation Check List

General installation

- Equipment compliant with standards. correctly selected & not damaged
- Equipment accessible for operation, Inspection & maintenance
- Equipment and accessories correctly connected
- Particular protective measures for special location
- Equipment and protective measures appropriate to external influences
- System installed to prevent mutual detrimental influence
- Conductors connected and identified
- Conductors selected for current carrying capacity and voltage drop
- Conductors routed in safe zone or protected against mechanical damage
- Presence of fire barriers, seals and protection against thermal effects

General installation (mechanical)

- Ventilation provided behind array to prevent overheating/fire risk
- Array frame & material corrosion proof
- Array frame correctly fixed and stable; Roof fixings weatherproof
- Cable entry weatherproof

Protection against overvoltage/electric shock

- Live parts insulated, protected by barrier/enclosure, placed out of reach or Class II
- Array frame equipotential bonding present (only relevant if required)
- Surge protection devices present (only relevant if required)
- RCD provided (only relevant if required)
- Frame correctly integrated with existing LPS installation

DC System

- Physical separation of ac and dc cables
- Dc switch disconnect fitted
- Dc cables – protective and reinforced insulation (only relevant if required)
- All dc components rated for operation at max dc system voltage ($V_{oc} \text{ stc} \times 1.25$)
- PV strings fused or blocking diodes fitted (only relevant if required)

AC System

- Ac isolator lockable in off position only
- Inverter protection settings to local regulations

Labeling & identification

- General labeling of circuits, protective devices, switches and terminals
- PV system schematic displayed on site
- Protection setting & installer details displayed on site
- Emergency shutdown procedure displayed on site
- Ac isolator clearly labeled
- Ac isolator / junction boxes suitably labeled
- Signs & labels suitably affixed and durable

Installer**Company Name:**

Registration No.:

Installation Supervisor Name:

Contractor License Number.:

Contact Telephone:

Email Address:

Date Installed:

Signature:

Name:

Date:

ABBREVIATION

LCD	Liquid Crystal Display
LED	Light Emitting Diode
MPPT	Maximum Power Point Tracking
PV	Photovoltaic
GFCI	Ground Fault Circuit Interrupter
Vdc	Voltage at the DC side
Vac	Voltage at the AC side
Vmpp	Voltage at the Maximum Power Point
Imp	Amperage at Maximum Power Point
Voc	Open Circuit Voltage
Isc	Short Circuit Current
AC	Alternating Current (Form of electricity supplied by Utility Company)
DC	Direct Current (Form of electricity generated by PV modules)
VDE 0126-1-1	German standards for establishing suitability for Grid Connection of the Inverter.
DC Switch	Switch in the DC Circuit. Disconnects DC source from Inverter. May be integrated or external to Inverter.