



Samil Power

Expert for PV Grid-tied Inverters



SolarRiver PV Grid-tied Inverter

Product Manual

SP-SR-V5-EN

Copyright Declaration

The copyright of this manual belongs to Samil Power Co., Ltd. Any corporation or individual should not plagiarize, partially copy or fully copy it (including software, etc.) , and no reproduction or distribution of it in any form or by any means. All rights reserved. Samil Power reserves the right of final interpretation. This information is subject to changes without notice.

Contents

1	NOTES ON THIS MANUAL	5
1.1	SCOPE OF VALIDITY	5
1.2	TARGET GROUP.....	5
1.3	SYMBOLS USED	5
2	SAFETY.....	6
2.1	APPROPRIATE USAGE	6
2.2	IMPORTANT SAFETY INSTRUCTIONS	6
2.3	EXPLANATION OF SYMBOLS.....	7
3	INTRODUCTION	9
3.1	BASIC FEATURES.....	9
3.2	ELECTRICAL BLOCK DIAGRAM	9
3.3	DIMENSION AND WEIGHT.....	10
4	TECHNICAL DATA	11
4.1	INPUT (DC).....	11
4.2	OUTPUT (AC)	12
4.3	EFFICIENCY, SAFETY AND PROTECTION	12
4.4	GENERAL DATA.....	13
5	FUNCTION	13
6	INSTALLATION	15
6.1	PACKAGING.....	15
6.2	INSTALLATION PRECAUTION.....	16
6.3	PREPARATION	17
6.4	INSTALLATION STEPS	17
6.5	CONNECTIONS OF THE PV POWER SYSTEM.....	18
6.6	RUN THE INVERTER	23

7	OPERATION METHOD	24
7.1	CONTROL PANEL	24
7.2	LCD FUNCTION	25
7.3	LCD INFORMATION.....	27
8	COMMUNICATION AND MONITORING	29
8.1	COMMUNICATION INTERFACE.....	29
8.2	COMMUNICATION.....	29
9	TROUBLESHOOTING	32
9.1	TROUBLESHOOTING	32
9.2	ROUTINE MAINTENANCE	34
10	DECOMMISSIONING	35
10.1	DISMANTLING THE INVERTER	35
10.2	PACKAGING.....	35
10.3	STORAGE	35
10.4	DISPOSAL.....	35
11	CONTACT SAMIL POWER	36

1 Notes on This Manual

This manual is an integral part of the inverter, Please read the product manual carefully before installation, operation or maintenance. Keep this product manual for future reference.

1.1 Scope of Validity

This installation guide describes the assembly, installation, commissioning, maintenance and failure search of the following Samil Power SolarRiver Series inverters.

SR1K5TLA1 SR2K2TLA1 SR2K8TLA1

SR3K3TLA1 SR4K4TLA1 SR4K4TLA1-PT SR5KTLA1

Store this manual where it will be accessible at all times.

1.2 Target Group

This manual is for qualified personnel. The tasks described in this manual must only be performed by qualified personnel.

1.3 Symbols Used

The following types of safety instructions and general information appear in this document as described below.



Danger !

Danger indicates a hazardous situation which, if not avoided, will result in death or serious injury.



Warning !

Warning indicates a hazardous situation which, if not avoided, could result in death or serious injury.



Caution !

Caution indicates a hazardous situation which, if not avoided, could result in minor or moderate injury.



Note !

Note provides tips that are valuable for the optimal operation of your product.

2 Safety

2.1 Appropriate Usage

The SolarRiver Series is a PV inverter which converts the DC current of a PV generator into AC current and feeds it into the public grid.

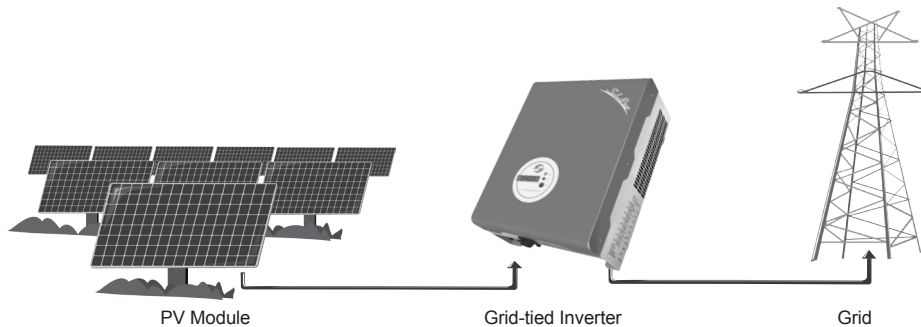

Figure 1 PV Grid-tied System





2.2 Important Safety Instructions

	<p>Danger ! Danger to life due to high voltages in the inverter!</p> <ul style="list-style-type: none"> • All work on the inverter must be carried out by qualified personnel only. • The appliance is not to be used by children or persons with reduced physical sensory or mental capabilities, or lack of experience and knowledge, unless they have been given supervision or instruction. • Children should be supervised to ensure that they do not play with the appliance.
	<p>Caution ! Danger of burn injuries due to hot enclosure parts!</p> <p>During operation, the upper lid of the enclosure and the enclosure body may become hot.</p> <ul style="list-style-type: none"> • Only touch the lower enclosure lid during operation.
	<p>Caution ! Possible damage to health as a result of the effects of radiation!</p> <ul style="list-style-type: none"> • Do not stay closer than 20 cm to the inverter for any length of time.
	<p>Note !</p> <p>Grounding the PV generator. Comply with the local requirements for grounding the PV modules and the PV generator. Samil Power recommends connecting the generator frame and other electrically conductive surfaces in a manner which ensures continuous conduction and ground these in order to have optimal protection of the system and personnel.</p>

2.3 Explanation of Symbols

This section gives an explanation of all the symbols shown on the inverter and on the type label.

● Symbols on the Inverter

Symbol	Explanation
	Danger to life due to high voltages in the inverter! There is residual voltage in the inverter. The inverter requires 5 minutes to discharge. • Wait 5 minutes before you open the upper lid or the DC lid.
	Beware of hot surface. The inverter can become hot during operation. Avoid contact during operation.
	Danger of high voltages Danger to life due to high voltages in the inverter!
	Caution, risk of electric shock! Only authorized personnel is allowed to set the DIP switch.

● Symbols on the Type Label

Symbol	Explanation
	CE mark. The inverter complies with the requirements of the applicable CE guidelines.

● Important Safety Instructions

When using the product, please do remember the below information to avoid the fire, lightning or other personal injury:

	Warning ! Ensure input DC voltage \leq Max. DC voltage .Over voltage may cause permanent damage to inverter or other losses, which will not be included in warranty! This chapter contains important safety and operating instructions. Read and keep this Operation Guide for future reference.
---	--



Warning !

Authorized service personnel must disconnect both AC and DC power from the SolarRiver Series inverter before attempting any maintenance or cleaning or working on any circuits connected to the SolarRiver Series inverter.

- Before using the SolarRiver Series inverter, read all instructions and cautionary markings on the SolarRiver Series inverter, and all appropriate sections of this guide.
- Use only attachments recommended or sold by Samil Power. Doing otherwise may result in a risk of fire, electric shock, or injury to persons.
- To avoid a risk of fire and electric shock, make sure that existing wiring is in good condition and that wire is not undersized. Do not operate the SolarRiver Series inverter with damaged or substandard wiring.
- Do not disassemble the SolarRiver Series inverter. It contains no user-serviceable parts. See Warranty for instructions on obtaining service. Attempting to service the SolarRiver Series inverter yourself may result in a risk of electric shock or fire and will void your warranty.
- To reduce the risk of electric shock, authorized service personnel must disconnect both AC and DC power from the SolarRiver Series inverter before attempting any maintenance or cleaning or working on any circuits connected to the SolarRiver Series inverter. Turning off controls will not reduce this risk.
- Keep away from flammable, explosive materials to avoid fire disaster.
- The installation place should be away from humid or corrosive substance.
- To avoid electric shock accident, please do not disassemble the inverter because there are high-voltage capacitances installed inside the inverter. Fatal High-voltage will remain in the inverter after its disconnection with grid after 5 minutes.
- To reduce the chance of short-circuits, authorized service personnel must use insulated tools when installing or working with this equipment.

3 Introduction

3.1 Basic Features

Congratulations on your purchase of a SolarRiver Series inverter from Samil Power. The SR Series inverter is one of the finest inverter on the market today, incorporating state-of-the-art technology, high reliability, and convenient control features.

- Advanced MCU control technology.
- Utilize the latest high-efficiency power component.
- Optimal MPPT technology.
- Advanced anti-islanding solutions.
- Excellent protections.
- IP65 protection level.
- Efficiency up to 97.6%.
- THD < 3%.
- Safe & Reliable: transformerless design with software and hardware protection.
- Friendly HMI.
 - ◇ LED status indications.
 - ◇ LCD display technical data, Human-Machine interaction through press key.
 - ◇ RS485/RS232 communication interface.
 - ◇ PC remote control.

3.2 Electrical block diagram

● Electrical block diagram

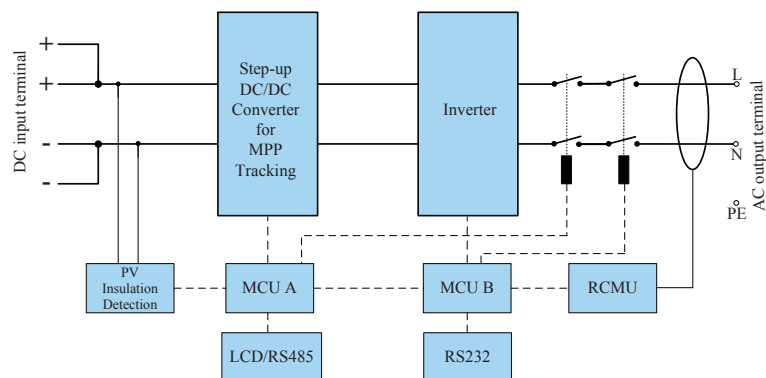

Figure 2 Electrical block diagram

● **Terminals of PV inverter**

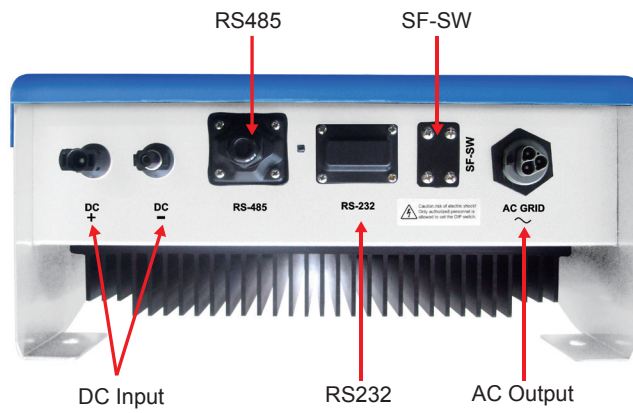

Figure 3 Terminals of PV inverter(1.5 kW~2.8 kW)

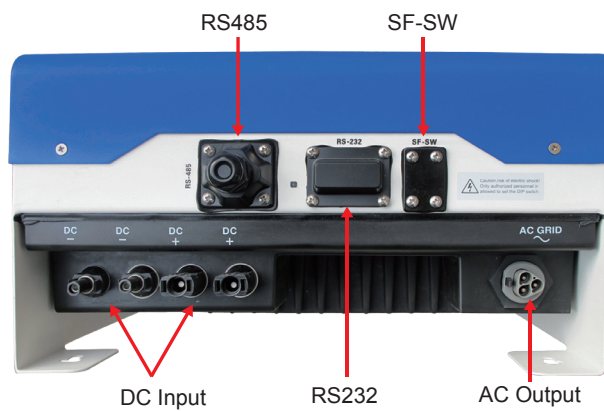



Figure 4 Terminals of PV inverter(3.3 kW~5 kW)



Caution !
About SF-SW. Risk of electric shock! Only authorized personnel is allowed to set the DIP switch.

3.3 Dimension and Weight

● **Dimension**

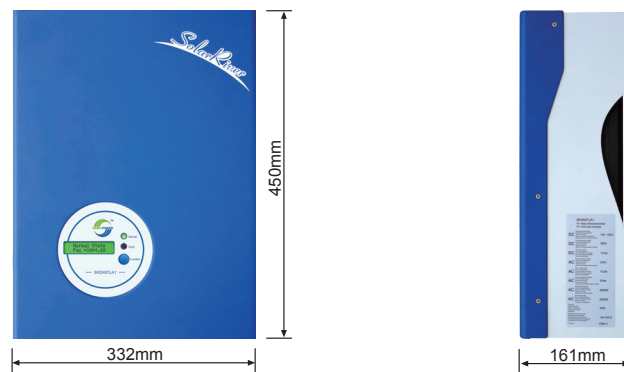

Figure 5 SR1K5TLA1/SR2K2TLA1/SR2K8TLA1

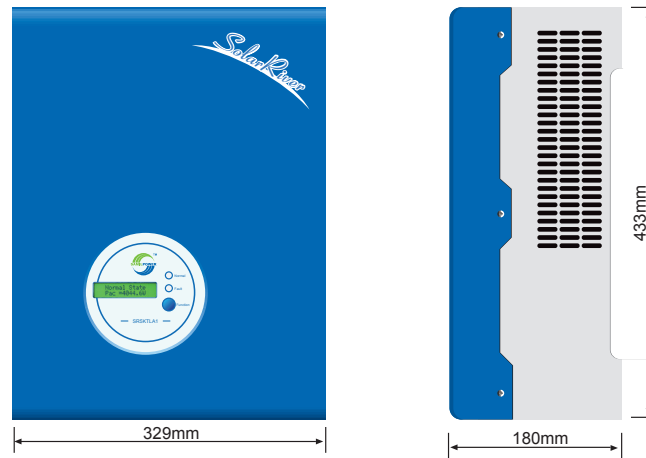

Figure 6 SR3K3TLA1/SR4K4TLA1/SR4K4TLA1-PT/SR5KTLA1

● **Weight**

Table 1 Weight

Model	SR1K5TLA1	SR2K2TLA1	SR2K8TLA1	SR3K3TLA1	SR4K4TLA1	SR4K4TLA1-PT	SR5KTLA1
Weight [kg]	17.1	17.5	17.9	18.9	19.2	19.2	19.4

4 Technical Data

4.1 Input (DC)

Model	SR1K5TLA1	SR2K2TLA1	SR2K8TLA1	SR3K3TLA1	SR4K4TLA1	SR4K4TLA1-PT	SR5KTLA1
Max. DC power [W]	1700	2300	3000	3480	4580	4000	5200
Max. DC voltage [V]	550						
Max. input Current [A]	9	11	13.5	17.5	22	22	26
Number of MPP trackers / Strings per MPP tracker	1 / 1			1 / 2			
MPPT voltage range (at rated power) [V]	180-500	200-500	210-500	200-500	200-500	200-500	200-500
Shutdown voltage / Start voltage [V]	70 / 100						

4.2 Output (AC)

Model	SR1K5TLA1	SR2K2TLA1	SR2K8TLA1	SR3K3TLA1	SR4K4TLA1	SR4K4TLA1-PT	SR5KTLA1
AC nominal power [W]	1500	2000	2600	3000	4000	3680	4600
Max. AC power [W]	1650	2200	2800	3300	4400	3680	5000
Max. AC current [A]	8.6	11	13.8	16	22	16	24
Nominal AC voltage / range [V]	230 / 180~270 *						
AC grid frequency / range [Hz]	50 / 47~52 *						
Power factor (cosφ)	1						
Total harmonic distortion (THDi) (at nominal power)	< 3%						
* Detailed parameter please see local grid standard.							

4.3 Efficiency, Safety and Protection

Model	SR1K5TLA1	SR2K2TLA1	SR2K8TLA1	SR3K3TLA1	SR4K4TLA1	SR4K4TLA1-PT	SR5KTLA1
Max. efficiency	96.8%	96.8%	97.0%	97.4%	97.6%	97.6%	97.6%
Euro-efficiency	95.8%	96.2%	96.3%	96.5%	97.1%	97.1%	96.8%
MPPT efficiency	99.9%						
Safety & Protection							
Overvoltage / under-voltage protection	Yes						
DC isolation impedance monitoring	Yes						
Ground fault protection	Yes						
Grid monitoring	Yes						
Ground fault current monitoring	Yes						
DC injection monitoring	Yes						

4.4 General Data

Model	SR1K5TLA1	SR2K2TLA1	SR2K8TLA1	SR3K3TLA1	SR4K4TLA1	SR4K4TLA1-PT	SR5KTLA1
Dimension (W/H/D) [mm]	332 / 450 / 161			329 / 433 / 180			
Weight [kg]	17.1	17.5	17.9	18.9	19.2	19.2	19.4
Cooling concept	Convection	Convection	Convection	Convection	Fan	Fan	Fan
Noise (typical) [dB]	<30	<30	<30	<30	<40	<40	<40
Operating temperature range [°C]	-20 °C ~ +60 (derating at 45 °C)						
Degree of protection	IP65						
Topology	Transformerless						
Internal consumption(night) [W]	0						
LCD display	Backlight, 16*2 character LCD						
Communication interfaces	RS485 / RS232						
Standard warranty	5 years						

5 Function

Operation Mode

【 Stand-by Mode 】

The stand-by mode means that the inverter is ready to but still not connect to the grid. Under this mode, it will continue check if PV array has enough power to feedback into grid. When the inverter passes dump load test after startup, it will change from stand-by mode to Checking mode.

【 Checking Mode 】

If inverter passed dump load test and no error/fault occurs, starts checking to deliver power.

【 On-grid Mode 】

Under this mode, SR series inverters convert PV array's DC into AC and feedback into grid.



CAUTION!

The inverter decreases the output power is normal in the condition of thermal protection, but if this phenomenon occurs frequently, you need to check the heatsink and the fan, or consider putting the inverter in the place where have better air flow. If the fan is too dirty, please clean it, and if output power decreases caused by electrical, please ask for professional supports.

【 MPPT Mode 】

The default setting is MPPT mode, the operation mode will return to MPPT after DC&AC restart.

【 Fault Mode 】

If any fault/error occurs, inverter stop delivering power until the fault/error is clear. Some fault/error will auto recover, and some may need manual restart.

【 Setting Mode 】

The user can get into the setting mode by press “Function” key for 5 seconds if DC exists. Please refer to operation method in chapter 7 for detailed information.

6 Installation

6.1 Packaging

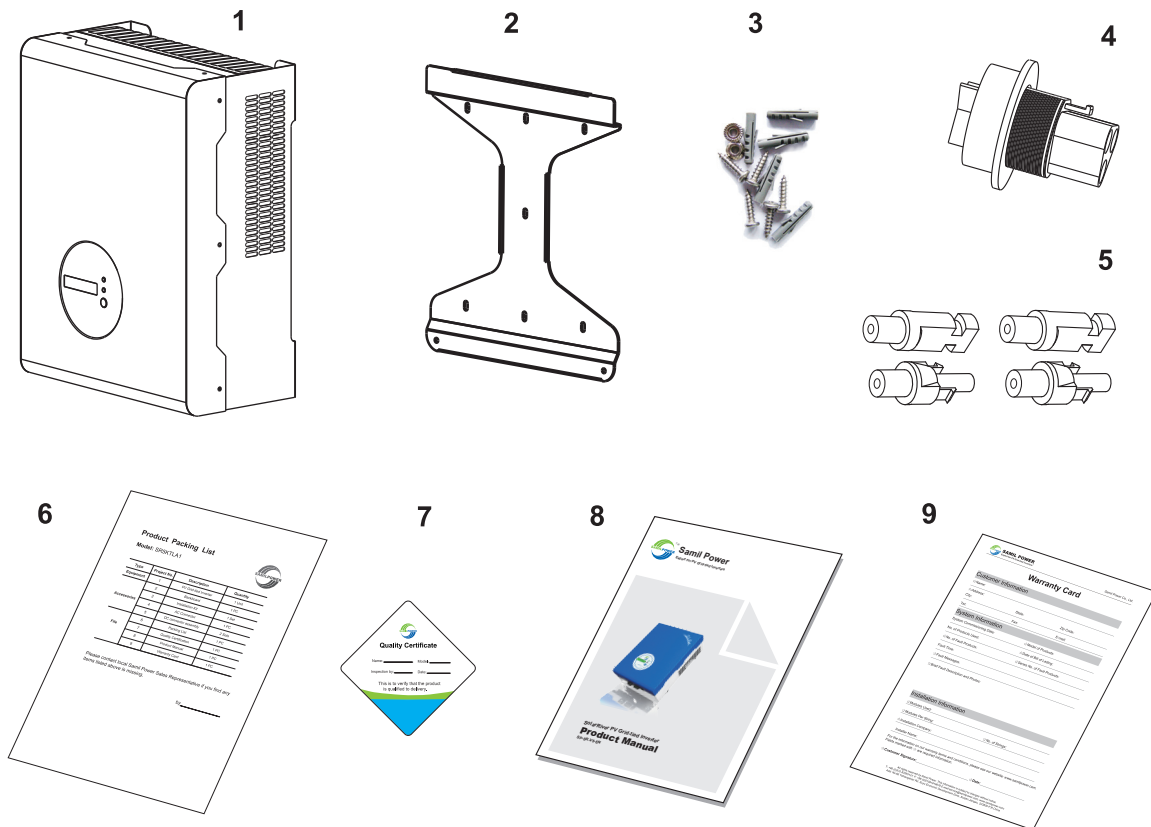

Type	Project No.	Description	QTY	Remark
Equipment	1	PV Grid-tied Inverter	1 unit	Installation Kit include: M5 flange nut, expansion screw, M5 screw rivet.
Accessories	2	Backboard	1 pc	
Accessories	3	Installation Kit	1 set	
	4	AC connector	1 pc	
	5	DC connector assembly	1 / 2	
Files	6	Packing list	1 pc	
	7	Quality certificate	1 pc	
	8	Product manual	1 pc	
	9	Warranty card	1 pc	

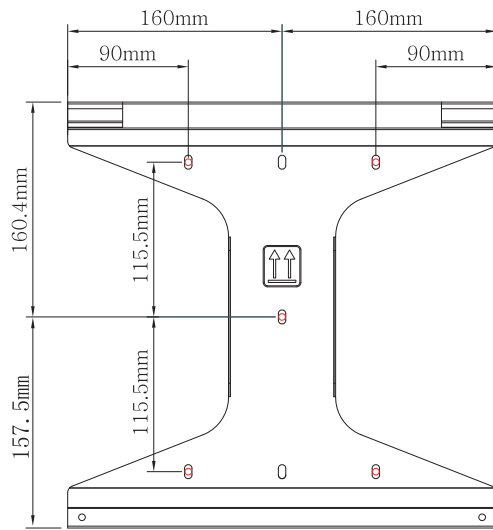

1.5-2.8 kW Inverter Backboard

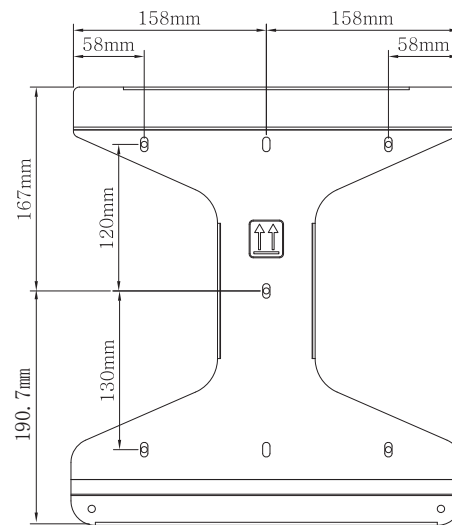

3.3-5 kW Inverter Backboard

Warning !

before installation and maintenance, AC and DC side doesn't carry electricity, but if DC side is just disconnected, capacitance still contains electricity, so please wait for at least 5 minutes to ensure the capacitors completely release the energy and inverter is not electrified.

Note !
Inverters must be installed by qualified person.

6.2 Installation precaution

Checking environment where system is installed.

Check whether the installation site does not fall into any of the following conditions:

- The ambient temperature is outside the range of tolerable ambient temperature (-20°C to +60°C, -4°F to +140°F,).
- Higher than the altitude of about 2,000 m above sea level.
- Prone to be damaged by sea water.
- Close to corrosive gas or liquid (for example, locations where chemicals are processed or the location where feed lots of poultry).
- Exposed to direct sunlight.
- Prone to be flooded or high levels of snow pack.

- Little or no air flow and high humidity.
- Exposed to steam, vapor, or water.
- Exposed to direct cool air.
- Near the television antenna or antenna cable.
- Ventilation is not enough to cool the inverter, that is to say, outdoors, the inverter requires. At least 30 cm (see table 2) of clearance among the units is needed, it is recommended that the same clearance between the units and the ground be used. Installing the inverter in the place mentioned above may cause the malfunction of the system caused by water

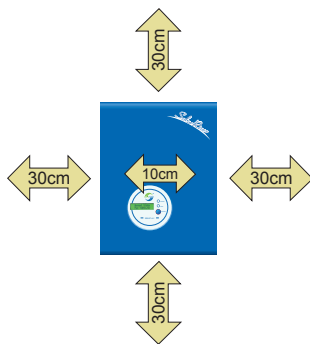

Position	Min. Size
Side	30cm
Top	30cm
Bottom	30cm
Front	10cm

Table 2 Available Space Size

or high temperature inside the inverter. Please let users know that Samil Power will not compensate the fault caused by the above situation.

6.3 Preparation

Below tools are needed before installation.

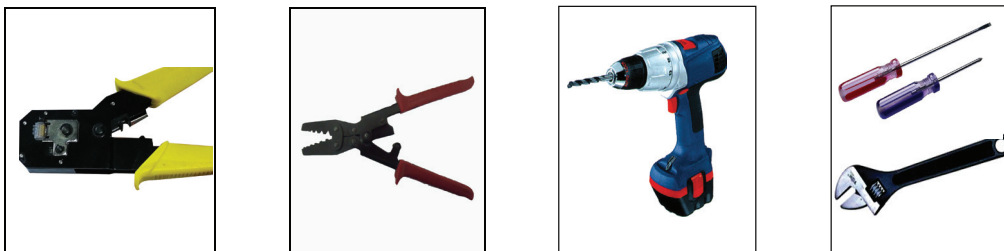

Installation Tools

Installation Tools: crimping pliers for binding post and RJ11, screwdriver and manual wrench and ϕ 6 driller.

6.4 Installation Steps

Step1: Drill holes in the wall with ϕ 6 driller according to the size of bracket. Keep drilling vertical to the wall, and don't shake when drilling to avoid damage to the wall.

The depth of the holes should be about 30mm and should be the same. After removing the dust in the holes, measure the net depth of the holes. If the depth is more than 33mm or less than 27mm, the expansion tubes wouldn't be installed and tightened.

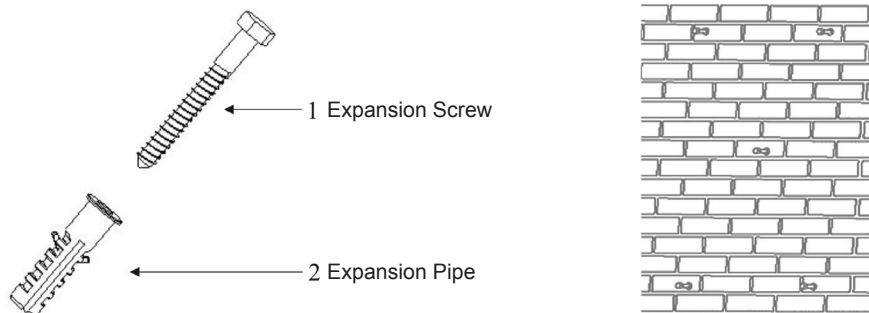

Figure 7 Installation of Expansion Pipe

Step2: Clean all dust outside/inside the hole and measure pitch-row before installation. It need repositioning and drilling holes if the hole with much error. Then put expansion pipe into the hole vertically, use rubber hammer to tap the pipe into the wall completely. After that, twist 2 screws into 2 corresponding pipes, another 2 screws should be twisted into pipes with gasket.

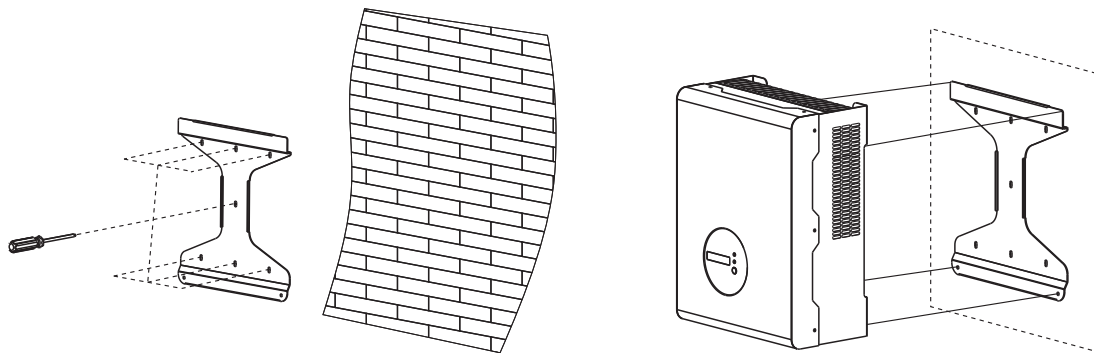

Figure 8 Bracket Installation

Step3: Use the bracket to install the inverter onto the narrow vertical panel (or wall). Put upper -part holes of the inverter onto the bracket, lower part onto the M5 screw rivet of the bracket (See figure 8).

Step 4: Use M5 flange nut to fix the bottom of the inverter.

Step 5: Complete the installation process.

6.5 Connections of the PV power system

● PV String

SR series inverters (SR3K3TLA1/SR4K4TLA1/SR4K4TLA1-PT/SR5KTLA1) can be connected in series into 2-strings PV modules. Please select PV modules with excellent function and reliable quality. Open-circuit voltage of module arrays connected in series should be <Max. DC (Table 3) input voltage; operating voltage should be conformed to MPPT voltage range.

Table 3 Max. DC Voltage Limitation

Model	SR1K5TLA1	SR2K2TLA1	SR2K8TLA1	SR3K3TLA1	SR4K4TLA1	SR4K4TLA1-PT	SR5KTLA1
Max. DC voltage	550 V						

Please use PV cable to connect modules to inverter. From junction box to inverter, voltage drop is about 1-2%. So we suggest the inverter install near PV module, in order to save cable and reduce DC loss.



Note !

Please don't connect the PV panel positive or negative to ground.

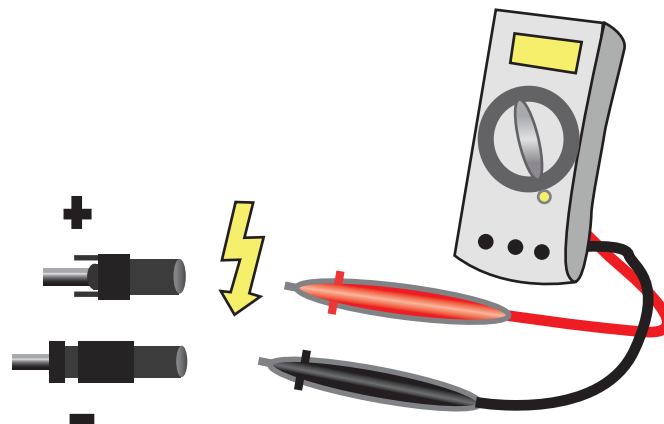

Figure 9 Use multimeter to measure module array voltage



Warning !

PV module voltage is very high which belongs to dangerous voltage range, please comply with electric safety rules when connecting.



Warning !

When there is something wrong with module arrays, modules can be connected with PV grid-tied inverter only after eliminating these problems.

● **AC Output**

SolarRiver series inverters are designed for single phase grid. Voltage range is from 180V to 260V (200V-270V for Australia), typical frequency is 50Hz. Other technical requests should comply with the requirement of local public grid.

Table 4 Cable and Micro-breaker Requirement

Model	SR1K5TLA1	SR2K2TLA1	SR2K8TLA1	SR3K3TLA1	SR4K4TLA1 /SR4K4TLA1-PT	SR5KTLA1
Cable (Cu)	4mm ²	4mm ²	4mm ²	4mm ²	4mm ²	4mm ²
Micro-Breaker	16A	20A	20A	25A	25A	32A

Micro-breaker should be installed between inverter and grid, and its rated fault current:
 $30\text{ mA} \leq I_{fn} \leq 300\text{ mA}$, Any load should not be connected with inverter directly.

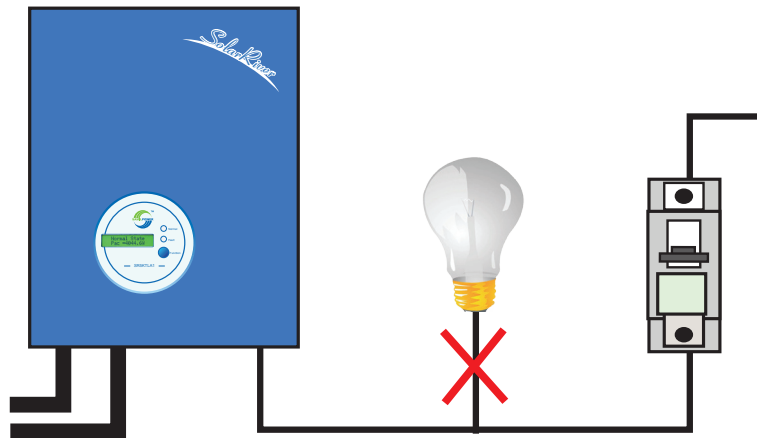

Figure 10 Incorrect Connections between Load and Inverter

Impedance of SR inverter AC connecting dot should be less than 2Ω. To ensure reliable anti-islanding function , PV cable should be used to ensure wire loss <1% than normal power. Moreover, length between AC side and grid connecting dot should be less than 50m. Below chart is cable length for SR3K3TLA1, section area and wire loss.

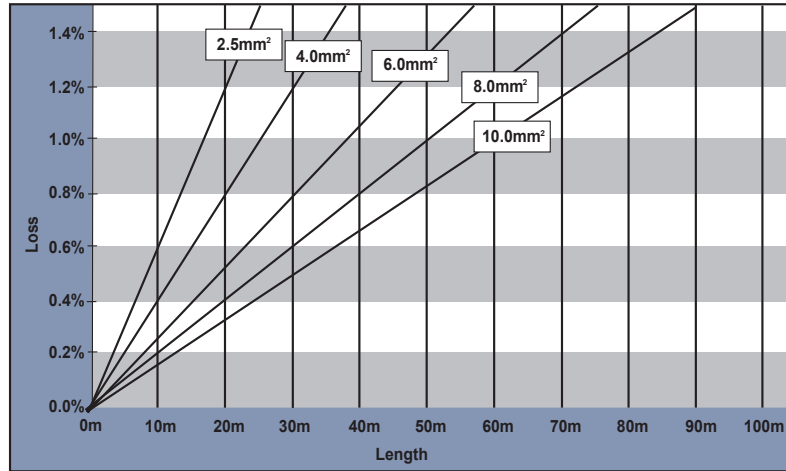

Figure 11 AC Cable Loss for SR3K3TLA1

This product has a professional IP66 AC waterproof connector. You have to wire AC by yourself. Please see figure 12 and 13 for AC connector disassembling guide.

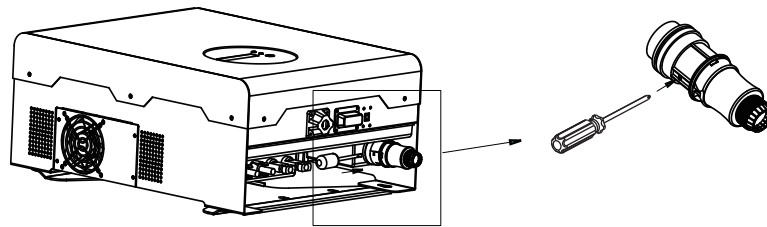

Figure 12 Disassembling AC Connector from Inverter

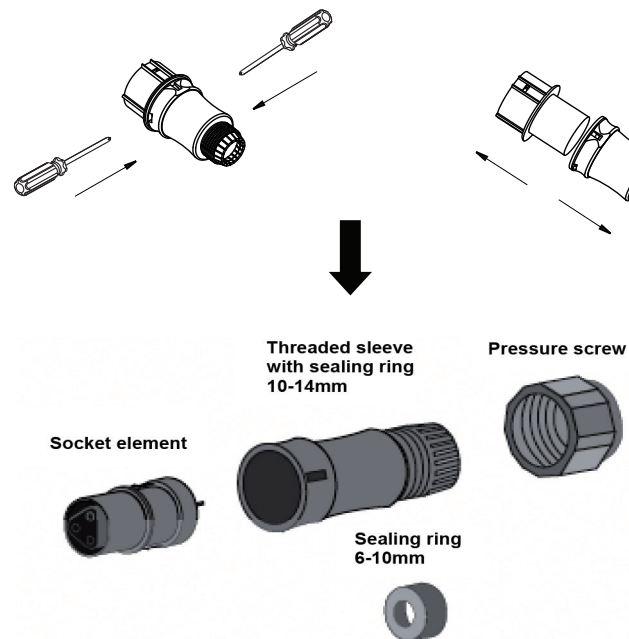

Figure 13 Disassembling AC Connector

Below shows the steps of wiring.

Step1: Put the threaded sleeve and pressure screw through the AC wire (See figure 14).

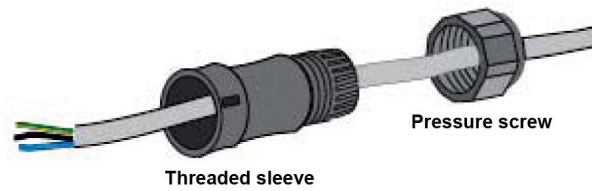

Figure 14

Step2: Wire the AC wire refer to below instructions.

- Screw the green-yellow wire to the ground terminator in the AC Connector (Figure 15).
- Screw the blue wire to the N(Neutral) terminator in the AC Connector.
- Screw the brown wire to the L(Line) terminator in the AC Connector.



Figure 15 AC Connector

Step3: Confirm all the wires should be screwed down(Figure 16).

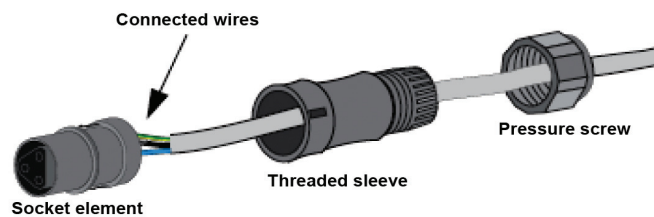

Figure 16

Step4: Screw down the threaded sleeve (Figure 17).

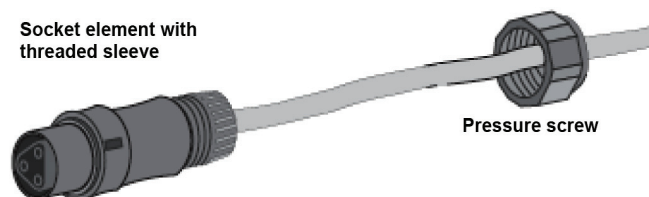

Figure 17

Step5: Screw down the pressure screw (Figure 18).

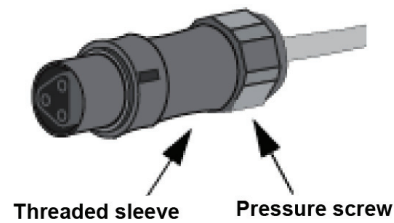

Figure 18

Step6: Connect AC connector to inverter (Figure 19).

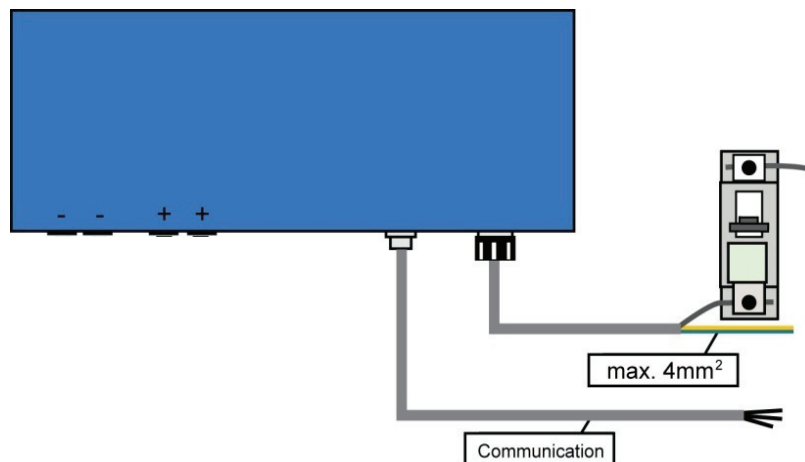

Figure 19

6.6 Run the inverter

- **Start inverter after checking all below steps.**

- Make sure all the DC breaker and AC breaker are disconnect.
- AC cable is connected to grid correctly.
- All PV panels are connected to inverter correctly, DC connectors which are not used sealed should be sealed by cover.

- **Start inverter**

- Turn on DC and AC side switches.
- Inverter will start up automatically when PV panels generate enough energy. Below is three different states when operating, which means inverter starting up successfully.

Waiting: Inverter is waiting to checking when output DC voltage from PV panels is

greater than 100V (lowest start-up voltage) but less than 150V (lowest operating voltage).

Checking: Inverter will check output environment automatically when DC output voltage of PV panels exceeds 150V and PV panels have enough energy to start inverter.

Normal: Inverter begins to operate normally with green light on. Meanwhile, feedback energy to grid, LCD displays present output power, inverter will stop feedbacks power to grid when PV power is not enough.



Note !

If inverter shows “**Fault**” status, please refer to Part 9.

7 Operation Method

7.1 Control Panel

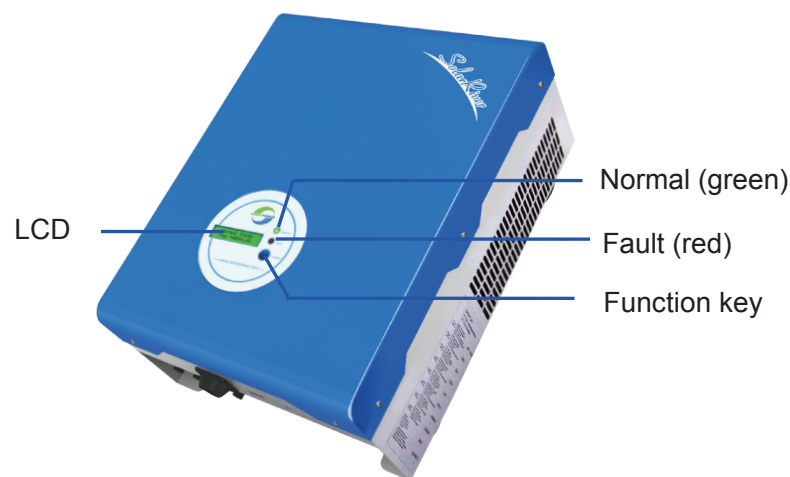

Figure 20 Control Panel

Normal (green) : The inverter is working in normal state.

Fault (red) : The system is in fault state.

Function key : To check the operating data, detailed usage see section 7.2.

7.2 LCD Function

The function key is used to set the LCD. It can alternate among different parameters and different languages.

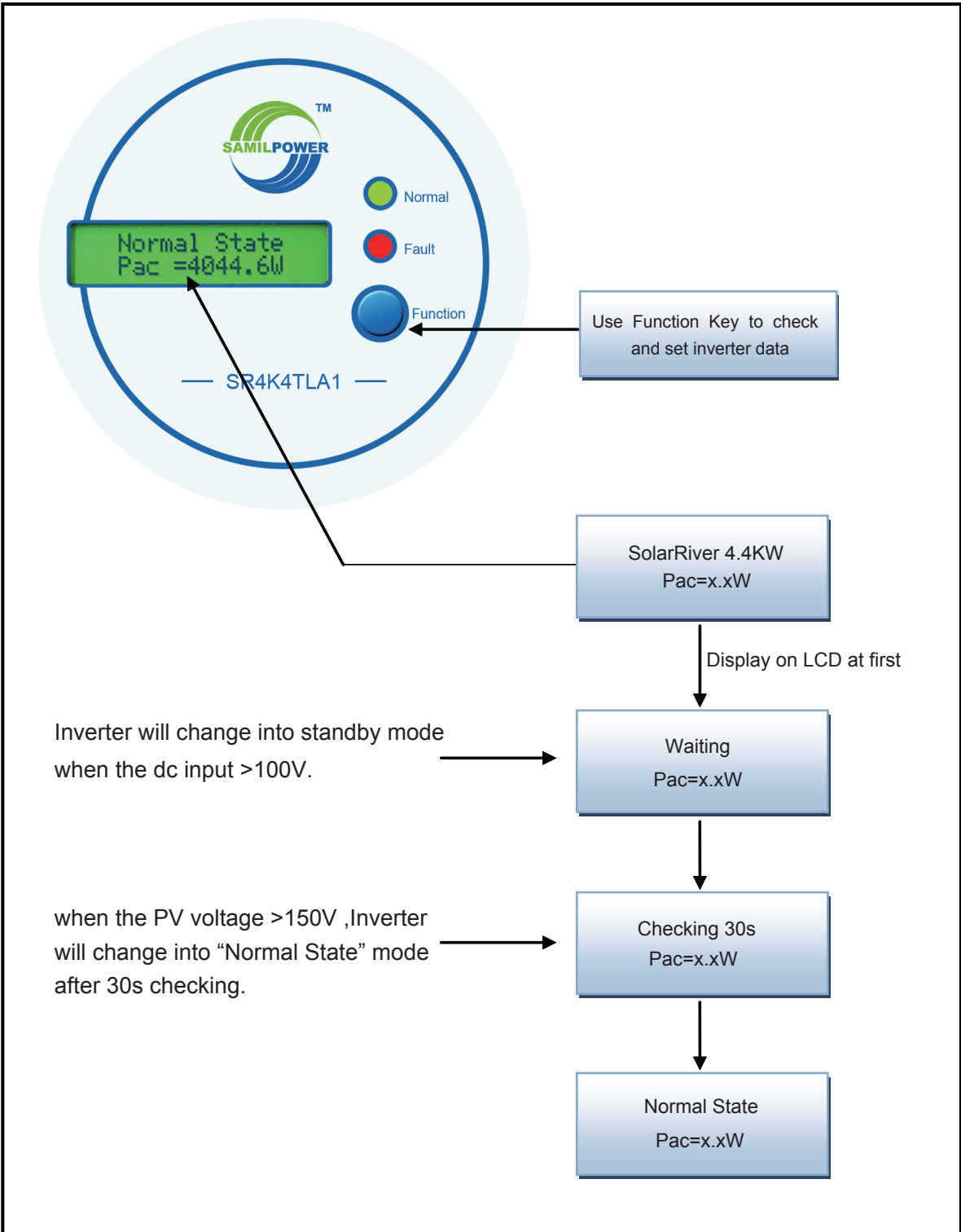

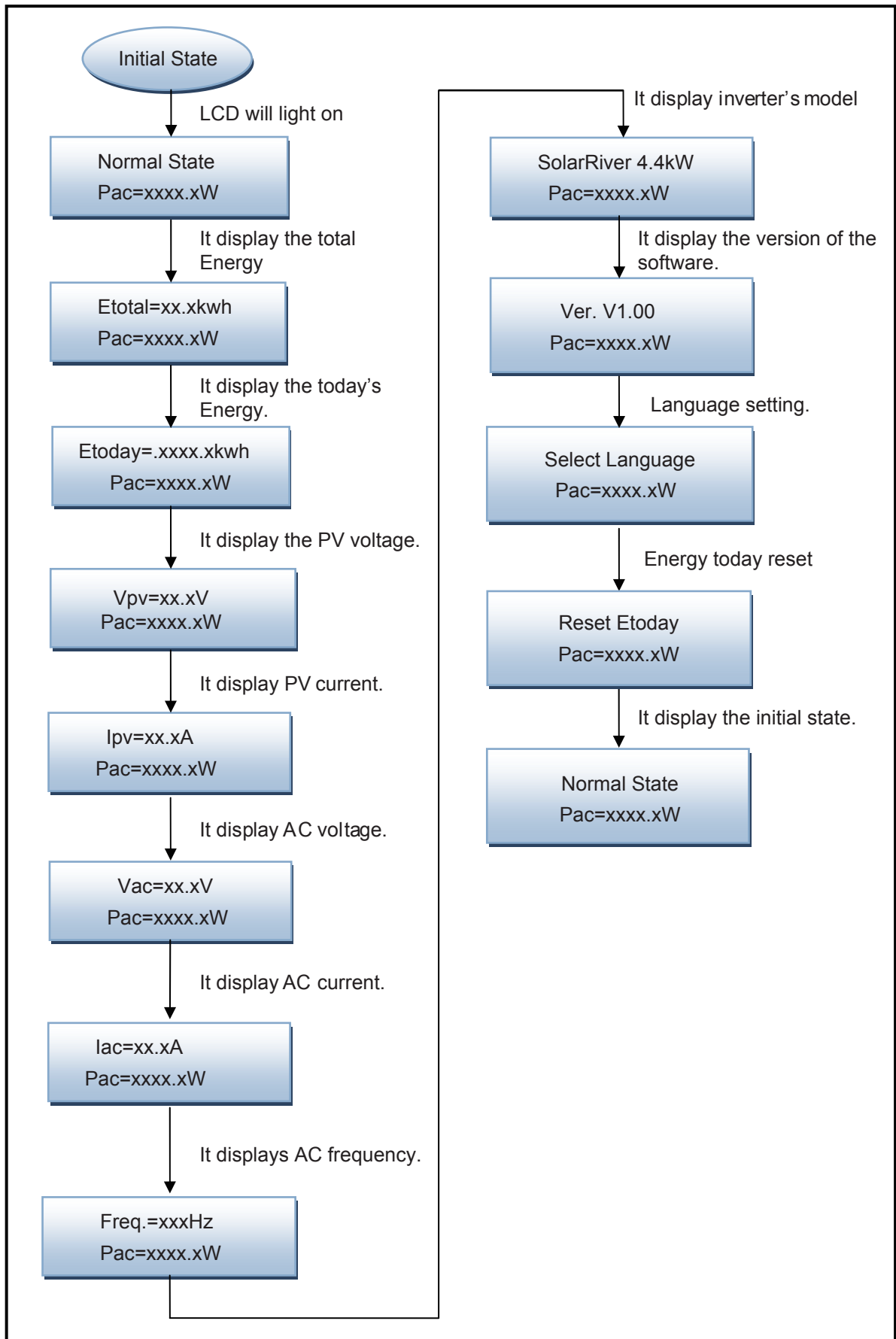

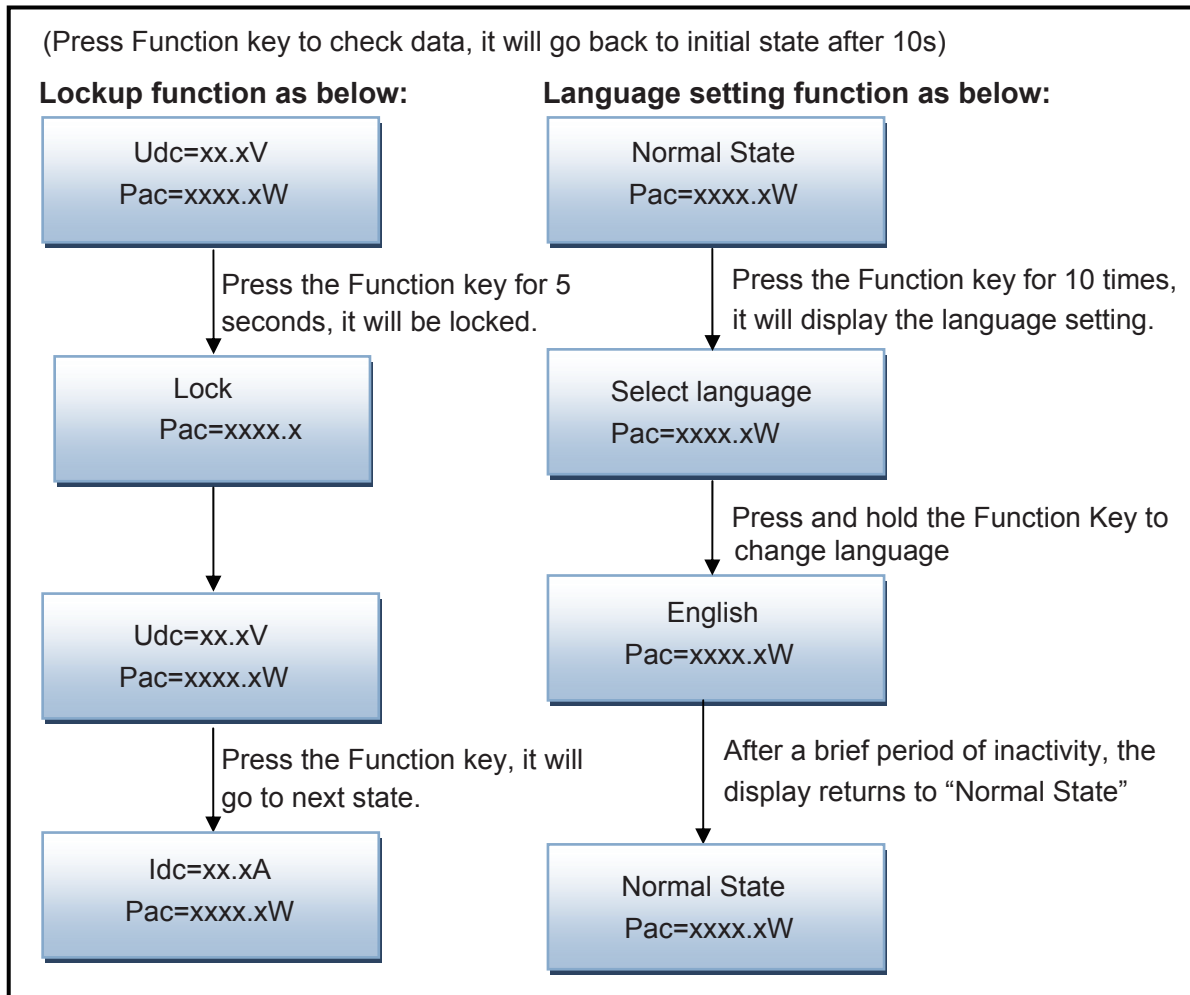

7.3 LCD Information

Table 5 LCD Information

Operating State	Information Display	Description
Working Condition		
Power Off	No display	DC input voltage < 70V, inverter will stop working
Initialization & Waiting	Waiting	70V < DC Input voltage ≤ 150V is standby mode
Checking	Checking	Input voltage > 150V is grid checking mode
Normal State	Normal state	Inverter is working in grid-tied mode

Flash	Flash	Upgrading software
Checking Parameters		
Real-time Power	Pac=xxxxW	Real-time output power
Calculate Energy Information	Ettotal=xxxxkwh	Total energy feedback to grid
Output Voltage	Vac=xxx.xV	Output voltage
Output Frequency	Freq.= xx.xHz	Output frequency
Output Current	Iac=xx.xA	Output Current
PV Input Voltage	Vpv= xxxV	PV input voltage
PV Input Current	Idc= xxx A	PV input current
Fault Information		
Isolation Fault	Isolation Fault	Grounding fault or surge voltage protection failure
Leakage Detecting	Ground I Fault	Leakage current over rating
Grid Fault	Fault OVR	AC Over voltage rating
	Fault UVR	AC Under voltage rating
	Fault OFR	AC Over frequency rating
	Fault UFR	AC Under frequency rating
No Utility	No Utility	No Utility
Fan Fault	Fan Fault	Fan locked or circuit fault
PV Over Voltage	PV Over Voltage	PV voltage \geq Max.DC voltage
Consistent Fault	Consistent Fault	CPU or other circuitry failure
Relay Failure	Relay Failure	Relay is failure between grid and inverters
DC INJ High	DC INJ High	DC injection in AC output over rated value.
EEPROM Failure	EEPROM Failure	EEPROM's failure
SCI Failure	SCI Failure	MCU internal communication failure
High DC Bus	High DC Bus	DC bus voltage is higher than the set

		value
DC Sensor Fault	DC Sensor Fault	Input DC detector failure
GFCI Failure	GFCI Failure	Leakage current detecting circuit failure
Others		
Lock	Lock	Froze the information
Reconnect	Reconnect	Reconnect to grid after relay disconnect
Inverter's Version	Ver xx.xx	Version information

8 Communication and Monitoring

8.1 Communication Interface

This product has an optional communication interface RS485/RS232. Operating information like output voltage, current, frequency, fault information, etc., can be delivered to PC or other monitoring equipment via RS485/RS232.

8.2 Communication

When user want to know the information of the power station and manage the entire power system. We offer below two types communications.

① RS232 Communication

RS232 is one standard communication interface. It transmits the data between PC and one single SR series inverters (Figure 21). For communication cable, one end is male connector, the other end is female connector.

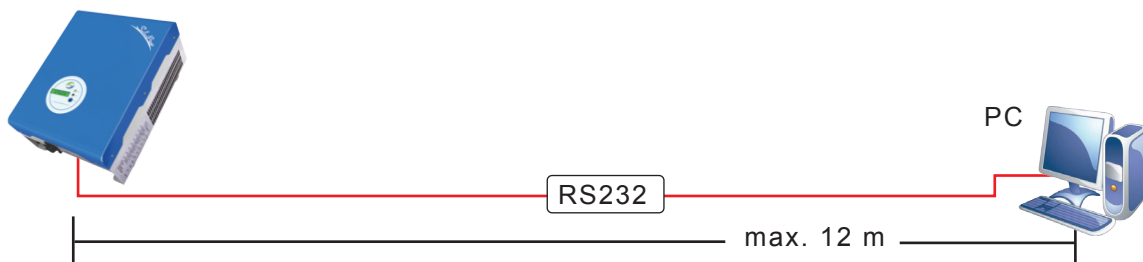

Figure 21 RS232 Communication Diagram



Figure 22 RS232 Communication Cable and Interface

Table 6 RS232 Pin Definition

Pin	1	2	3	4	5	6	7	8	9
Function	NC	TxD	RxD	NC	Common (GND)	NC	NC	NC	NC

One inverter can only be communicated with one PC at the same time through RS232 port. Thus this method is generally used for single inverter's communication, for examples, software updating and serviceman's testing.

② RS485 Communication (Several inverters)

- Communication

RS485 is generally for multi inverters' communication. Up to 32 inverters could communicate at the same time, but wire length should be $\leq 1200m$. System monitor SolarPower Manager should be configured to realize one PC communicates with multi inverters at the same time. Through PC SolarPower Manager could get real time PV plants operating data. Please see Installation Guide of SolarPower Manager for more information.

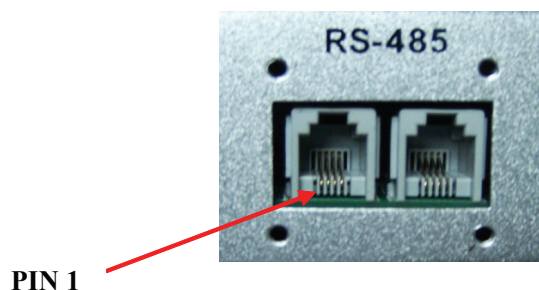

Figure 23 RS485 Interface of SR Series Inverter

Table 7 RS485 Pin Definition

Pin	1	2	3	4
Function	TX+	TX-	RX+	RX-

● Connections

Select high-quality network cable, peel the isolation surface, Select 4 wires (brown, white brown, orange, white orange), then follow the same order with the press pliers push into the 4-wire RJ11 crystal head.

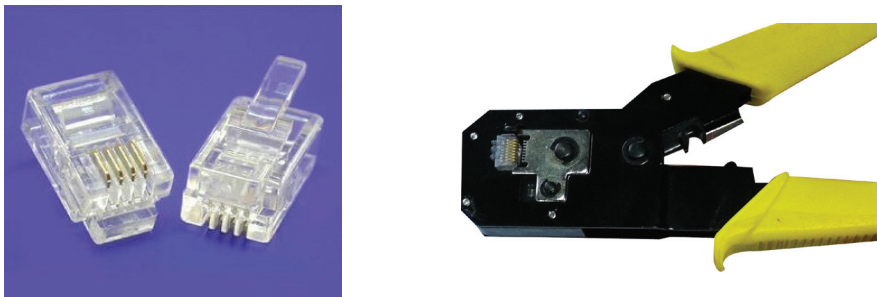

Figure 24 4-line RJ11

Table 8 4-line RJ11

4-line RJ11 Wire No.	Wire Color
1	Brown
2	White Brown
3	Orange
4	White Orange

Connect the system as blow (Figure25), you can easily monitoring the PV power station.

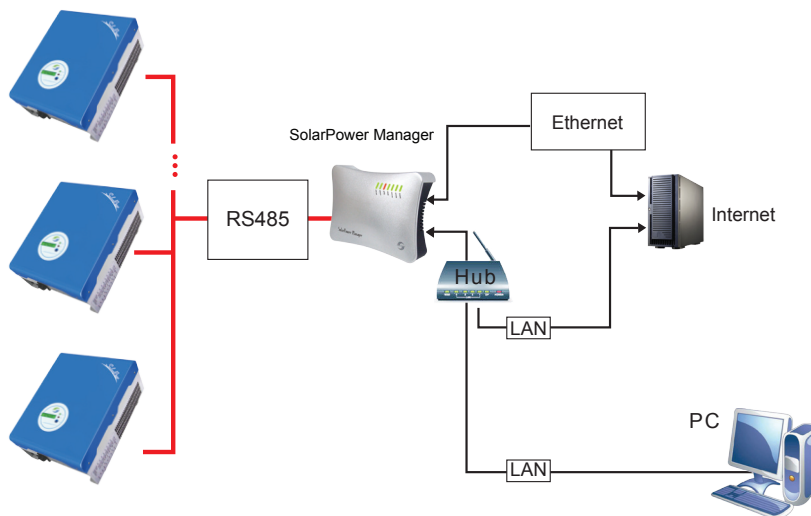

Figure 25 SolarPower Manager Monitoring Diagram

9 Troubleshooting

9.1 Troubleshooting

This section contains information and procedures for solving possible problems with the SolarRiver series inverters, and provides you with troubleshooting tips to identify and solve most problems that could occur with the SolarRiver series inverters.

This section will help you narrow down the source of any problems you may encounter.

Please read the following troubleshooting steps.

- Check the warning or fault messages on the System Control Panel or Fault codes on the inverter information panel. If a message is displayed, record it before doing anything further.
- Attempt the solution indicated in Table 9.
- If your inverter information panel is not displaying a Fault light, check the following list to make sure that the present state of the installation allows proper operation of the unit.
 - Is the inverter located in a clean, dry, adequately ventilated place?
 - Have the DC input breakers been opened?
 - Are the cables adequately sized and short enough?
 - Are the input and output connections and wiring in good condition?
 - Are the configurations settings correct for your particular installation?
 - Are the display panel and the communications cable properly connected and undamaged?

Contact Samil Power Customer Service for further assistance. Please be prepared to describe details of your system installation and provide the model and serial number of the unit.

Table 9 Troubleshooting list

Faults	Diagnosis and Solutions
Grid Faults	<ul style="list-style-type: none"> -Waiting for one minute, grid will go back to normal working state. -Making sure that grid voltage and frequency complies with standards. -Or, please seek for help from us.
No Utility	<ul style="list-style-type: none"> -Off to grid. -Please check grid-connection, like wire, interface, etc. -Checking grid usability. -Or seek for help from us.
PV Over Voltage	<ul style="list-style-type: none"> -Checking the panel's open-circuit voltage whether the value is similar or already >Max.DC voltage. -Please seek help from us when voltage \leq Max.DC voltage.
DC INJ High	<ul style="list-style-type: none"> -DC injection is higher than the set value. -Wait for one minute. -Please seek for help from us if it does not go back to normal state.
SCI Failure	<ul style="list-style-type: none"> -Disconnect PV (+) , PV (-) with DC input, and re-connect them. -Please seek for help from us if it can not go back to normal state.
DC Sensor Fault	<ul style="list-style-type: none"> -Disconnect PV (+) , PV (-) with DC input, and re-connect them. -Please seek for help from us if it can not go back to normal state.
Isolation Fault	<ul style="list-style-type: none"> -Check the impedance among PV (+)、PV (-) and ground. SR1K5TLA1~SR5KTLA1 >1Mohm -Please seek for help from us if it can not be detected or the impedance value is not big enough.
Consistent Fault	<ul style="list-style-type: none"> -Disconnect the PV (+), PV (-) with DC input, then reconnect them. -Please seek for help from us if it can not go back to normal state.

<p>Fan Fault</p>	<p>-Check the fan whether it is blocked . -Check the wire of fan whether it is normal . -Please seek for help from us if it can not go back to normal state .</p>
<p>Relay Failure</p>	<p>-Disconnect the PV (+), PV (-) with DC input, then reconnect them. -Please seek for help from us if it can not go back to normal state.</p>
<p>Ground I Fault</p>	<p>-Leakage current is too high. -Disconnect DC and AC connector, check the surrounding equipment on the AC side. -Reconnect the input connector and check the state of inverter after troubleshooting. -Please seek for help from us if it can not go back to normal state.</p>
<p>EEPROM Failure</p>	<p>-Disconnect the PV (+), PV (-) with DC input, then reconnect them. -Please seek for help from us if it can not go back to normal state.</p>
<p>High DC Bus</p>	<p>-Disconnect the PV (+), PV (-) with DC input, then reconnect them. -Check L line and N line to see whether it has connection faults. -Please seek for help from us when this fault happens.</p>
<p>GFCI Failure</p>	<p>-Disconnect the PV (+), PV (-) with DC input, then reconnect them. -Please seek for help from us if it can not go back to normal state.</p>

9.2 Routine Maintenance

Inverters generally do not need any maintenance or correction, but need to ensure cooling fan not be covered by any dust or dirties.

- **Inverter cleaning**

Please use electric compressing dryer, soft dry cloth or brush to clean inverters. Water, corrosive chemical substance or intense cleaning agent is not allowed to clean the cooling fan.

- **Cooling fin cleaning**

To ensure inverter performance and long-period usage, back heat emitter needs to be left with available space, side fan cannot be covered with dust or snow as it will affect airflow. Please use compressing air, soft cloth or brush to clean cooling fin, not water, corrosive chemical substance or intense cleaning agent.

10 Decommissioning

10.1 Dismantling the Inverter

- Disconnect the inverter from DC Input and AC output.
- Remove all connection cables from the inverter.
- Remove the inverter from the bracket.

10.2 Packaging

If possible, please pack the inverter with the original packaging.

If it is no longer available, you can also use an equivalent carton that meets the following requirements.

- Suitable for loads more than 25 kg.
- With handle.
- Can be fully closed.

10.3 Storage

Store the inverter in dry place where ambient temperatures are always between

-20 °C ~ +60 °C.

10.4 Disposal

Please be sure to deliver wasted inverters and packing materials to certain site, where can assist relevant department to dispose and recycle.

11 Contact Samil Power

If you have any questions about SR series inverter, please call service support hotline:

+86 510 83593131. Please keep following information to better our service for you.

- a. Inverter's Model.
- b. Inverter's Serial No..
- c. Communication Method.
- d. PV modules' Model.



Samil Power

Expert for PV Grid-tied Inverters

Samil Power Co., Ltd.

Marketing & Sales Office

Add: No.1608, Huishan Ave. Huishan District, Wuxi
City, Jiangsu Province, P.R.China 214174

Tel: +86 510 83593131

Fax: +86 510 81819678

E-mail: service@samilpower.com

<http://www.samilpower.com>

Factory

Add: No.66 Taihangshan Road,
Suyu Economic Development Zone, Suqian City,
Jiangsu Province, P.R.China 223800

Tel: +86 527 88754666

Fax: +86 527 84453877