



User Manual

-Installation
-Operation

Omniksol-3k-TL2
Omniksol-4k-TL2
Omniksol-5k-TL2

Omnik New Energy Co., Ltd.

Catalog

1.	Notes on this manual	3
1.1	Scope of Validation	3
1.2	Symbols Used.....	3
1.3	Target Group.....	4
2.	Preparation	5
2.1	Safety Instructions.....	5
2.2	Explanations of Symbols on Inverter.....	7
3.	Product Information.....	8
3.1	Overview	8
3.2	Major Characteristics	9
3.3	Datasheet.....	10
4.	Packing checklist	12
4.1	Assembly parts.....	12
4.2	Product Appearance	13
4.3	Product Identification.....	14
4.4	Further Information.....	14
5.	Installation.....	15
5.1	Safety.....	15
5.2	Mounting Instructions	15
5.3	Safety Clearance.....	16
5.4	Mounting Procedure.....	17
5.5	Safety lock.....	19
6.	Electrical Connection	20
6.1	Safety	20
6.2	AC Side Connection.....	20
6.3	DC Side Connection.....	23
6.4	Communication and Monitoring Device.....	28
7.	Display and Operation	29
7.1	LCD Panel.....	29
7.2	Commissioning.....	30

7.3	Operation	30
7.4	State Information.....	40
8.	Communication Setting.....	41
8.1	GPRS Card	41
8.2	Installation of communication card	42
8.3	Register on monitoring website	45
8.4	Login monitoring System.....	49
8.5	WiFi card.....	54
8.6	Network Settings	55
8.7	Ethernet card.....	64
8.8	Installation of Ethernet card	66
9.	Recycling and Disposal.....	68
10.	Troubleshooting	69
11.	Abbreviation.....	71
12.	Contact	72

1. Notes on this manual

1.1 Scope of Validation

The main purpose of this User's Manual is to provide instructions and detailed procedures for installing, operating, maintaining, and troubleshooting the following three types of Omnik New Energy-Solar Inverters:

- Omniksol-3k-TL2
- Omniksol-4k-TL2
- Omniksol-5k-TL2

Please keep this user manual all time available in case of emergency.

1.2 Symbols Used



DANGER

DANGER indicates a hazardous situation which, if not avoided, will result in death or serious injury.



WARNING

WARNING indicates a hazardous situation which, if not avoided, can result in death or serious injury or moderate injury.



CAUTION

CAUTION indicates a hazardous condition which, if not avoided, can result in minor or moderate injury.



NOTICE

NOTICE indicates a situation that can result in property damage, if not avoided.

1.3 Target Group

- Chapter 1, 2, 3, 4, 7, 8, 9, 10, 11 and chapter 12 are intended for anyone who is intended to use Omnik Grid Tie Solar Inverter. Before any further action, the operators must first read all safety regulations and be aware of the potential danger to operate high-voltage devices. Operators must also have a complete understanding of this device's features and functions.



WARNING

Do not use this product unless it has been successfully installed by qualified personnel in accordance with the instructions in Chapter 5. "Installation"

- Chapter 5 and chapter 6 are only for qualified personnel who are intended to install or uninstall the Omnik Grid Tie Solar Inverter.



NOTICE

Hereby qualified personnel means he/she has the valid license from the local authority in:

- Installing electrical equipment and PV power systems (up to 1000 V).
- Applying all applicable installation codes.
- Analyzing and reducing the hazards involved in performing electrical work.
- Selecting and using Personal Protective Equipment (PPE).

2. Preparation

2.1 Safety Instructions



DANGER

DANGER due to electrical shock and high voltage

DO NOT touch the operating component of the inverter, it might result in burning or death.

TO prevent risk of electric shock during installation and maintenance, please make sure that all AC and DC terminals are plugged out.

DO NOT stay close to the instruments while there is severe weather conditions including storm, lighting etc.



WARNING

The installation, service, recycling and disposal of the inverters must be performed by qualified personnel only in compliance with national and local standards and regulations. Please contact your dealer to get the information of authorized repair facility for any maintenance or repairmen. Any unauthorized actions including modification of product functionality of any form will affect the validation of warranty service; Omnik may deny the obligation of warranty service accordingly.



NOTICE

Public utility only

The PV inverter designed to feed AC power directly into the public utility power grid; do not connect AC output of the device to any private AC equipment.



CAUTION

The PV inverter will become hot during operation; please don't touch the heat sink or peripheral surface during or shortly after operation.

Risk of damage due to improper modifications. Never modify or manipulate the inverter or other components of the system.

2.2 Explanations of Symbols on Inverter

Symbol	Description
	Dangerous electrical voltage This device is directly connected to public grid, thus all work to the inverter shall only be carried out by qualified personnel.
	DANGER to life due to high electrical voltage! There might be residual currents in inverter because of large capacitors. Wait 10 MINUTES before you remove the front lid.
	NOTICE, danger! This device directly connected with electricity generators and public grid.
	Danger of hot surface The components inside the inverter will release a log of heat during operation, DO NOT touch aluminum housing during operating.
	An error has occurred Please go to Part 10 “Trouble Shooting” to remedy the error.
	This device SHALL NOT be disposed of in residential waste Please go to Part 9 “Recycling and Disposal” for proper treatments.
	Without Transformer This inverter does not use transformer for the isolation function.
SAA	Standards Association of Australian The inverter complies with the requirement of the AS4777.
CE	CE Mark Equipment with the CE mark fulfils the basic requirements of the Guideline Governing Low-Voltage and Electromagnetic Compatibility.
	No unauthorized perforations or modifications Any unauthorized perforations or modifications are strictly forbidden, if any defect or damage (device/person) is occurred, Omnik shall not take any responsibility for it. Electrical Installation & Maintenance shall be conducted by licensed electrician and shall comply with Australia National Wiring Rules.

3. Product Information

3.1 Overview

- Industrial Layout



- Excellent Heat Elimination



- Effective Shield For DC/AC/Communication Connections



3.2 Major Characteristics

Omnik inverter has following characteristics which make Omnik inverter “High Efficiency, High Reliability, High Cost Effective Ratio”

- Wide DC input voltage and current range, enables more PV panels connected.
- Wide MPP voltage range ensure high yield under various weather conditions.
- High MPP tracking accuracy, ensure the minimum power loses during converting.
- Complete set of protection methods.

Also, following protection methods are integrated in Omnik inverter:

- Internal overvoltage
- DC insulation monitoring
- Ground fault protection
- Grid monitoring
- Ground fault current monitoring
- DC current monitoring
- Integrated DC switch

3.3 Datasheet

Type	Omniksol-3k-TL2	Omniksol-4k-TL2	Omniksol-5k-TL2
Input (DC)			
Max. PV Power	3400W	4500W	5000W
Max DC Voltage	590V	590V	590V
Nominal DC Voltage	360V	360V	360V
Operating MPPT Voltage Range	120 - 550V	120 - 550V	120 - 550V
MPPT Voltage Range at Nominal Power	150 - 500V	200 - 500V	200 - 500V
Start up DC Voltage	150V	150V	150V
Turn off DC Voltage	120V	120V	120V
Max. DC Current	12A/12A	16A/16A	18A/18A
Isc PV	16A/16A	20A/20A	20A/20A
Number of MPP trackers	2	2	2
Max. inverter back feed current to the array	0	0	0
Max. Input Power for each MPPT	2000W	2600W	3000W
Number of DC Connection for each MPPT	1/1	1/1	1/1
DC Connection Type	MC4 connector	MC4 connector	MC4 connector
Output (AC)			
Max. AC Apparent Power	3300VA	4400VA	5000VA**
Nominal AC Power(cos phi = 1)	3000W	4000W	4600W**
Nominal Grid Voltage	220V/230V/240V	220V/230V/240V	220V/230V/240V
Nominal Grid Frequency	50Hz/60Hz	50Hz/60Hz	50Hz/60Hz
Max. AC Current	14.4A	19.0A	22.0A
maximum output fault current	16A	20A	24A
maximum output protection current	20A	22A	25A
AC inrush current	<100A	<100A	<100A
Grid Voltage Range*	185-276V	185-276V	185-276V
Grid Frequency Range*	45-55Hz/55-65Hz	45-55Hz/55-65Hz	45-55Hz/55-65Hz
Power Factor	0.9 capacitive...0.9inductive	0.9 capacitive...0.9inductive	0.9 capacitive...0.9inductive
Total Harmonic Distortion (THD)	<2%	<2%	<2%
Feed in Starting Power	30W	30W	30W
AC Connection Type	Plug-in connector	Plug-in connector	Plug-in connector
Efficiency			
Max. Efficiency (at 360Vdc)	98.2%	98.2%	98.2%
Euro Efficiency (at 360Vdc)	97.3%	97.5%	97.5%
MPPT Efficiency	99.9%	99.9%	99.9%
Safety and Protection			
Protection Functions	Array ground insulation resistance monitoring	Output over current protection	
	Residual current monitoring	Surge protection	
	Array polarity reverse monitoring	Output over/under voltage protection	
	Array over voltage protection	Output over/under frequency protection	
	Anti-island protection	Over temperature protection	

	Array over current protection	Output short circuit protection
Protection Class	I (According to IEC 62103)	
Overvoltage Category	PV II / Mains III (According to IEC 62109-1)	
Reference Standard		
Safety Standard	EN 62109, AS/NZS 3100	
EMC Standard	EN 61000-6-1, EN 61000-6-3, EN 61000-6-2, EN 61000-6-4, EN61000-3-2, EN61000-3-3, EN61000-3-11, EN61000-3-12	
Grid Standard	VDE-AR-N-4105, VDE 0126-1-1, RD1699, CEI0-21, C10/11, G83/2, UTE C15-712-1, AS4777, CQC	
Physical Structure		
Dimensions (WxHxD)	352x421x162.5mm	
Weight	16.5kg	
Environmental Protection Rating	IP 65 (According to IEC 60529),Outdoor	
Cooling Concept	Internal fan convection	
Mounting Information	Wall bracket	
General Data		
Operating Temperature Range	-25°C to +60°C(derating above 45°C)	
Relative Humidity	0% to 100%, no condensation	
Max. Altitude (above sea level)	2000m	
Noise Level	< 40dB	
Class of pollution	II	
Islanding protection	Initiative, Frequency disturbance	
DRM command	DRM0, DRM5, DRM6, DRM7, DRM8	
Isolation Type	Transformerless	
Display	3 LED, Backlight,20 x 4 Character LCD	
Data Communication Interfaces	RS485(WiFi, GPRS, intergrated)	
Standard Warranty	5 -25 years optional	

*The AC voltage and frequency range may vary depending on specific country grid

**4600VA, 4600W with VDE-AR-N-4105

4. Packing checklist

4.1 Assembly parts

After you receive the Omnik inverter, please check if there is any damage on the carton, and then check the inside completeness for any visible external damage on the inverter or any accessories. Contact your dealer if anything is damaged or missing.



A



B



C



D

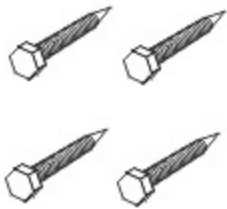

E

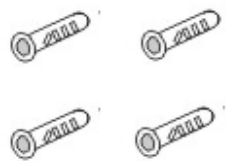

F

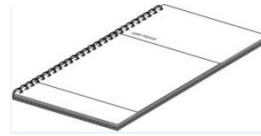

G

Object	Quantity	Description
A	1	Omnik inverter
B	2 pairs	DC connector
C	1	AC connector
D	1	Wall mounting bracket
E	4	Screw (ST6×50)
F	4	Expansion tube
G	1	Installation and operating instructions

4.2 Product Appearance

- Front

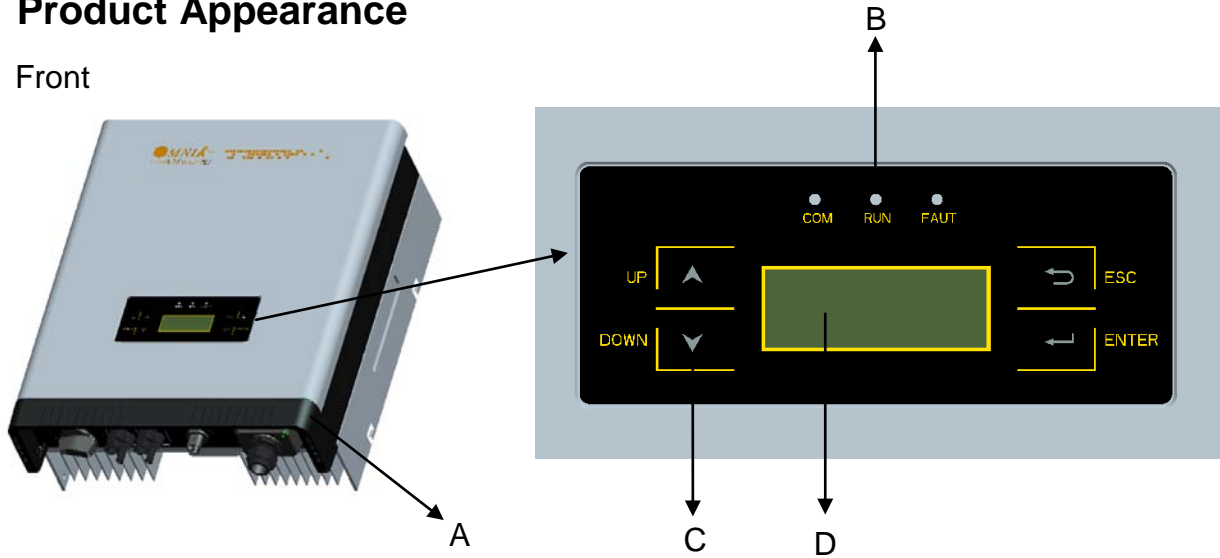

Object	Description
A	Removable front shield
B	LED light (3 pcs)
C	Function keys for displays and choice of language(4 pcs)
D	Monitoring LCD with backlighting

- Bottom

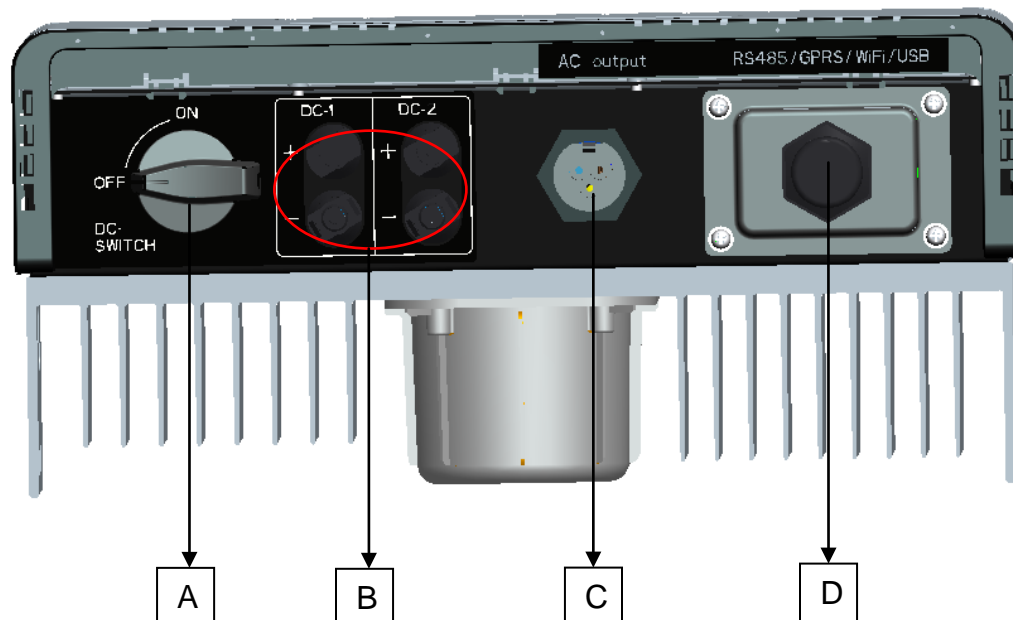

Object	Description
A	DC switch
B	Plug connectors for DC input
C	Terminal for grid connection (AC output)
D	Communication interface(RS485/GPRS/WiFi/USB)

4.3 Product Identification

You can identify the inverter by the side name plate. Information such as type of the inverter, as well as inverter specifications are specified on the side name plate. The name plate is on the middle part of the right side of the inverter housing. And the following figure is the side name plate example as on **Omniksol-5k-TL2**.

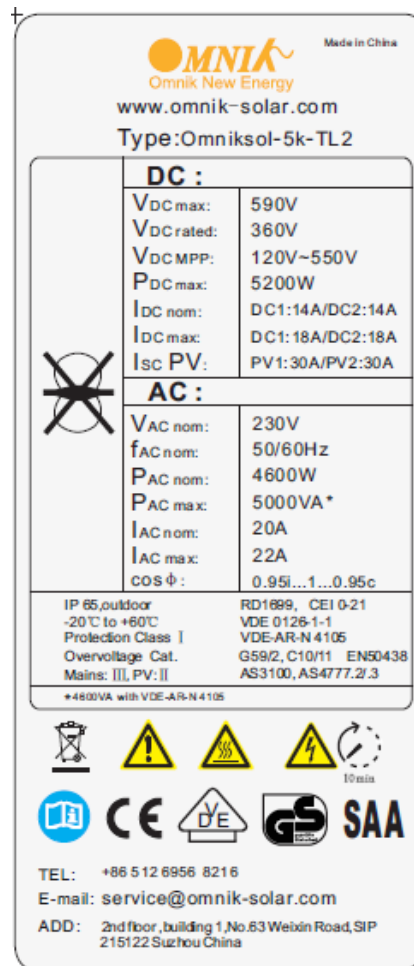

4.4 Further Information

If you have any further questions concerning the type of accessories or installation, please check our website www.omnik-solar.com or contact our service hotline.

5. Installation

5.1 Safety



DANGER

DANGER to life due to potential fire or electricity shock.

DO NOT install the inverter near any inflammable or explosive items.

This inverter will be directly connected with **HIGH VOLTAGE** power generation device; the installation must be performed by qualified personnel only in compliance with national and local standards and regulations.



NOTICE

NOTICE due to the inappropriate or the harmonized installation environment may jeopardize the life span of the inverter.

Installation directly exposed under intensive sunshine is not recommended.

The installation site **MUST** have good ventilation condition.

5.2 Mounting Instructions

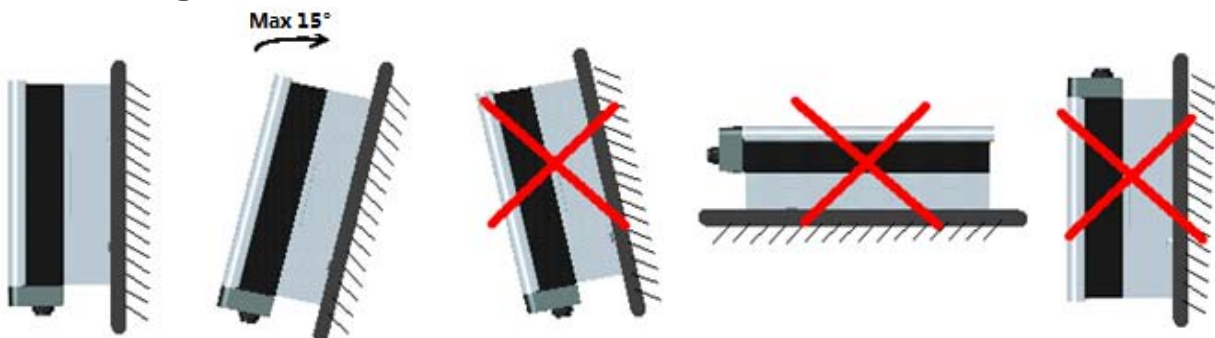

- Omnik inverter is designed for indoors and outdoors installation
- Please mount the inverter in the direction as illustrated above

- Install the inverter in the vertical direction is recommended, with a max.15 degrees backwards.
- For the convenience of checking the LCD display and possible maintenance activities, please install the inverter at eye level.
- Make sure the wall you selected is strong enough to handle the screws and bear the weight of the inverter
- Ensure the device is properly fixed to the wall
- It is not recommended that the inverter is exposed to the strong sunshine, because the excess heating might lead to power reduction
- The ambient temperature of installation site should be between -25°C and +60 °C
- Make sure the ventilation of the installation spot, not sufficient ventilation may reduce the performance of the electronic components inside the inverter and shorten the life of the inverter

5.3 Safety Clearance

Observe the following minimum clearances to walls, other devices or objects to guarantee sufficient heat dissipation and enough space for pulling the electronic solar switch handle.

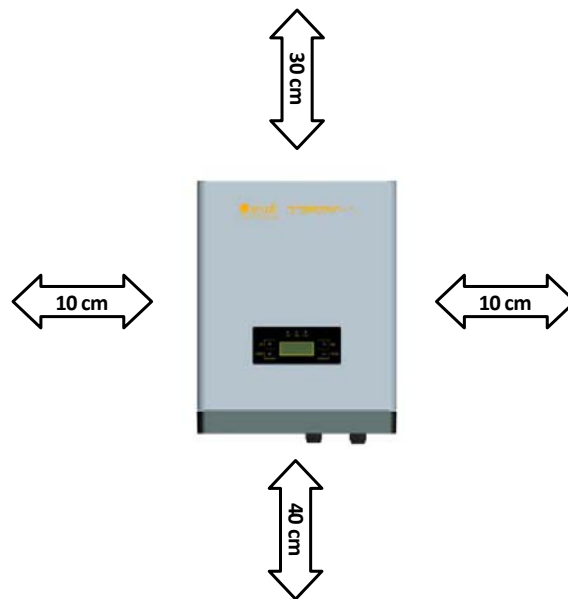

Direction	Minimum clearance
Above	30 cm
Below	40 cm
Sides	10 cm

5.4 Mounting Procedure

1. Mark 4 positions of the drill holes on the wall according to the wall mounting bracket in the carton box.

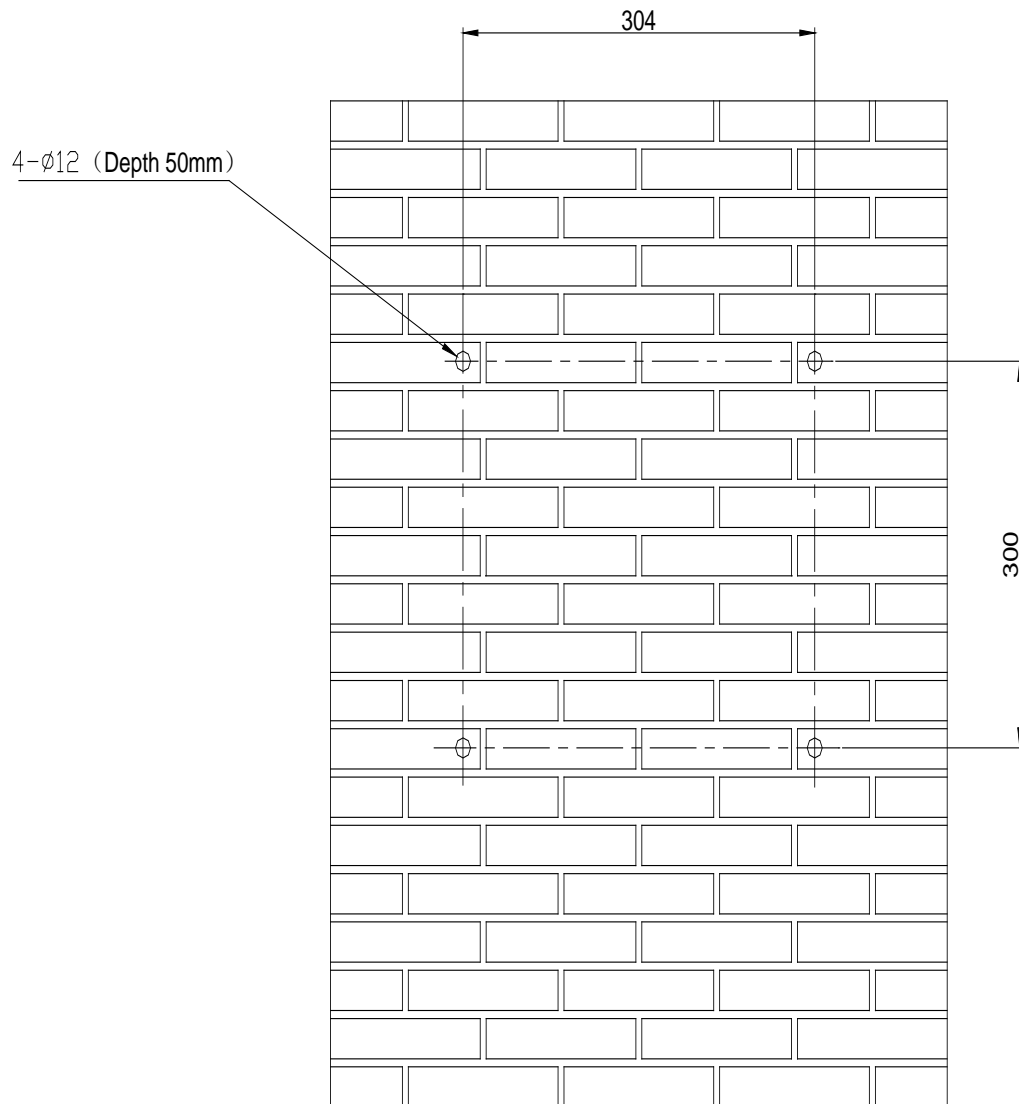

2. According to the marks, drill 4 holes in the wall. Then place four expansion tubes in the holes using a rubber hammer. Next make 4 screws through the mounting holes in the bracket, and then tighten the screws into the expansion tubes. So far, the wall mounting bracket is fixed already.

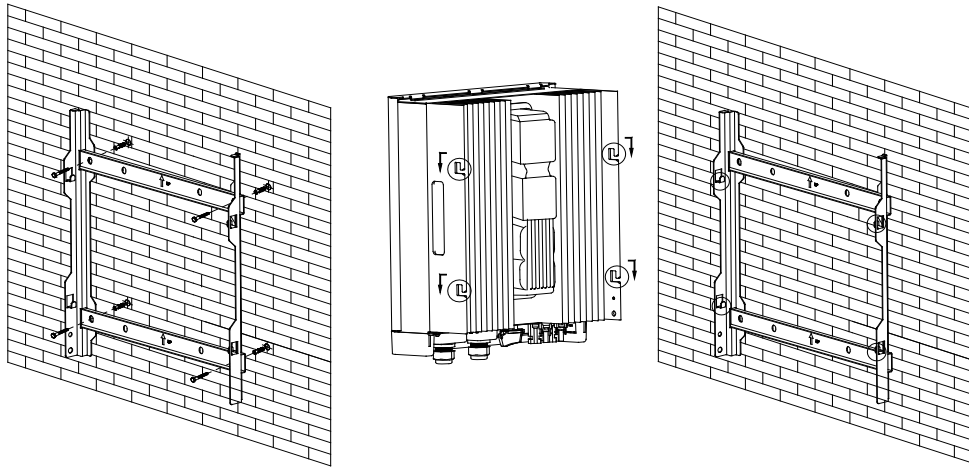

3. Check the 4 holes in the backside of the inverter. Then lift the inverter carefully, align the 4 holes in the inverter and the 4 hooks on the bracket, and finally attach the inverter to the hooks slightly.

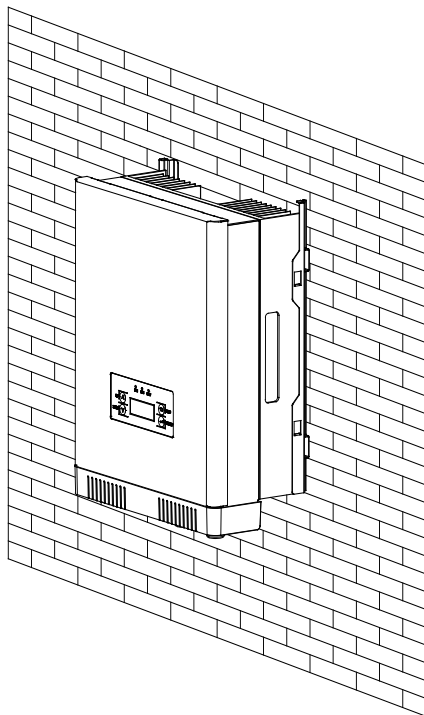

5.5 Safety lock

After the inverter is hanging up on the bracket, lock up the device and the bracket together at the Lower Left Corner of the inverter (as the picture showed below).

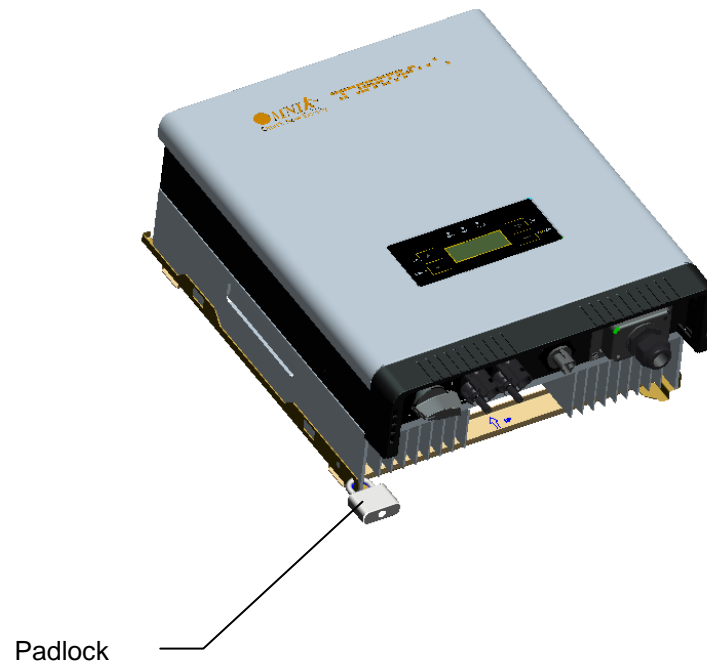

Recommended padlock dimension:

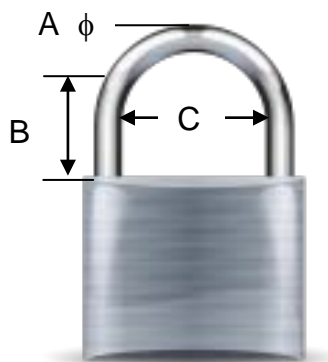

A. Shackle Diameter	5~7 mm
B. Vertical Clearance	8~15 mm
C. Horizontal Clearance	12~20 mm
Stainless, solid hanger and secured lock cylinder	



NOTICE

For further maintenance and possible repair, please keep the key of the padlock in a safe place.

6. Electrical Connection

6.1 Safety



DANGER

DANGER to life due to potential fire or electricity shock.

With the inverter powered, comply with all prevailing national regulations on accidents prevention.

This inverter will be directly connected with **HIGH VOLTAGE** power generation device; the installation must be performed by qualified personnel only in compliance with national and local standards and regulations.



NOTICE

Electrical connections shall be carried out in accordance with the applicable regulations, such as conductor sections, fuses, PE connection.

6.2 AC Side Connection



DANGER

DANGER to life due to potential fire or electricity shock.

NEVER connect or disconnect the connectors under load.

1. Integrated RCD and RCM

The Omniksol inverter is equipped with integrated RCD (Residual Current Protective Device) and RCM (Residual Current Operated Monitor). The current sensor will detect the volume of the leakage current and compare it with the pre-set value, if the leakage current exceeds the permitted range, the RCD will disconnect the inverter from the AC load.

2. Assembly Instructions



NOTICE

Use a residual current protective device (**residual operating current: 100mA**).



NOTICE

Use **12-10AWG (4-6mm²)** copper wire for all AC wiring connections to Omnik inverter. Use only solid wire or stranded wire.

In order to reduce the line loss of AC side (no more than 1% of P_{out}), Omnik suggest that the length of AC cable from the inverter to the distribution box should not exceed the limit below.

Model	Rated current	Length of cable	
		4 mm ²	6 mm ²
Omniksol-3k-TL2	13A	20m	30m
Omniksol-4k-TL2	17.4A	15m	22m
Omniksol-5k-TL2	21.7A	-	18m

- 1) Remove length y of **N,L** conductor 35mm(1.38")/**PE** conductor 40mm(1.57") sheath of AC cable terminal, length x about 14mm(0.55") of the inner wrapper, then dress the conductor terminals with ferrules or tin soldering.

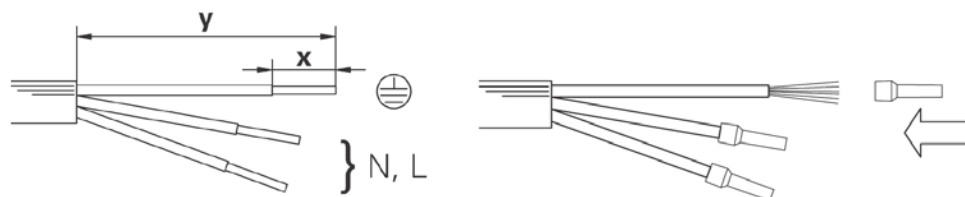

- 2) Check that all parts of AC connector are present. Then slide hex nut onto the cable and insert the cable end through clamp ring.

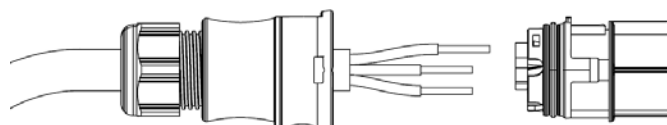

- 3) Insert the **stripped N, L and PE conductor terminal** to the appointed holes, use a cross screwdriver to tighten it with tightening torque 1Nm.

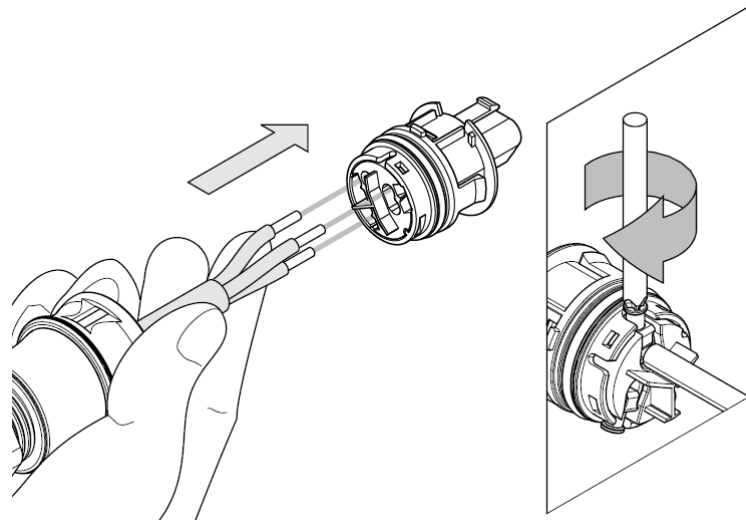

- 4) Insert the connector to clamp ring with two click sound and then tighten the hex nut with tightening torque 4Nm.

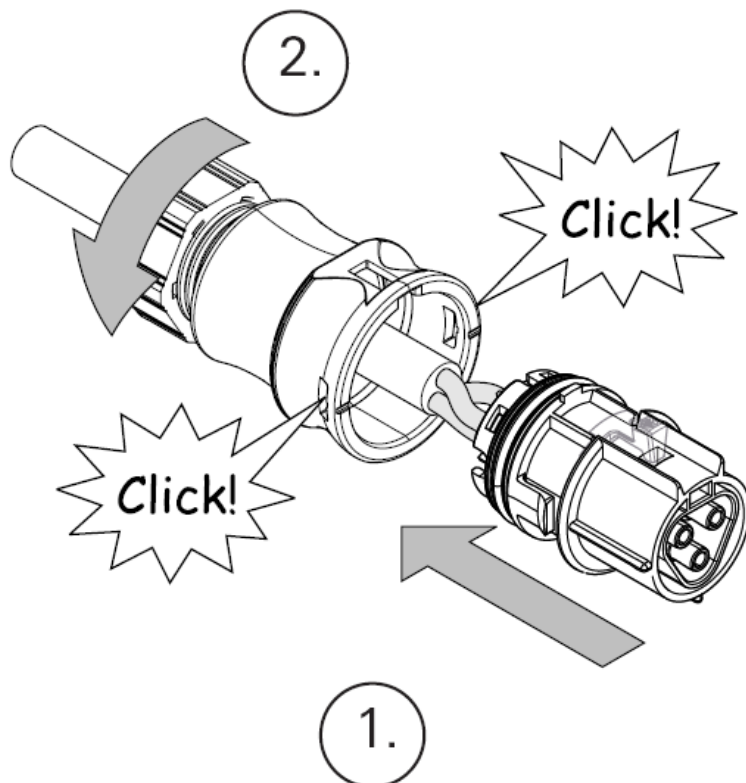

- 5) Finally connect the straight plug to the AC terminal on inverter. **Pay attention to the polarity of the terminals to avoid wrong connecting.**

6.3 DC Side Connection



DANGER

DANGER to life due to potential fire or electricity shock.
NEVER connect or disconnect the connectors under load.



DANGER

NEVER connect the ground lead of PV module to the inverter.

For Omniksol-3k-TL2, Omniksol-4k-TL2 and Omniksol-5k-TL2, there are two MPP Trackers, and the DC characteristics of them are illustrated as the following table.

Inverter Type	MPP Tracker	Max. DC Power	Max. DC Voltage	Max. DC Current
Omniksol-3k-TL2	2	3400W	590V	12*2A
Omniksol-4k-TL2		4600W		16*2A
Omniksol-5k-TL2		5200W		18*2A

In order to reduce the line loss of DC side (no more than 1% of P_{in}), Omnik suggest that the length of DC cable for each cable section should not exceed the limit below.

Model	Length of cable	
	2.5 mm ²	4 mm ²
Omniksol-3k-TL2	30m	48m
Omniksol-4k-TL2	40m	64m
Omniksol-5k-TL2	50m	80m

MC4 Assembly instructions

 If, during self assembly, parts and tools other than those stated by MC are used or if the preparation and assembly instructions described here are disregarded then neither safety nor compliance with the technical data can be guaranteed.

 For protection against electric shock, PV-connectors must be isolated from the power supply while being assembled or disassembled.

 The end product must provide protection from electric shock.

 The use of PVC cables is not recommended.

 Unplugging under load: PV plug connections must not be unplugged while under load. They can be placed in a no load state by switching off the DC/AC converter or breaking the DC circuit interrupter. Plugging and unplugging while under voltage is permitted.

 It is inadvisable to use non-tinned cables of type H07RN-F, since with oxidized copper wires the contact resistances of the crimp connection may exceed the permitted limits.

 Disconnected connectors should be protected from dirt and water with sealing caps.

 Plugged parts are watertight IP67. They cannot be used permanently under water. Do not lay the MC-PV connectors on the roof surface.

 See the MC catalogue 2 solar lines for technical data and assembled parts.

PV-Female cable coupler



PV-KBT4

PV-Male cable coupler



PV-KST4

Optional



PV-SSH4

Touch protection, mated/unmated	IP67/IP2X	Rated current	17A(1,5mm ² /16AWG) 22A(2,5mm ² /14AWG) 30A(4mm ² ,6mm ² /10AWG)
Ambient temperature range	-40°C... 90°C (IEC/CEI) -40°C... 75°C(UL) -40°C ...70°C (UL:14AWG)	Rated voltage	1000V (IEC/CEI) 600V (UL)
Upper limiting temperature	105°C (IEC/CEI)	Safety class	II

Note: The DC connector is MC4 type; you can order the specified tools at MC website: <http://www.multi-contact.com>.

Tools required

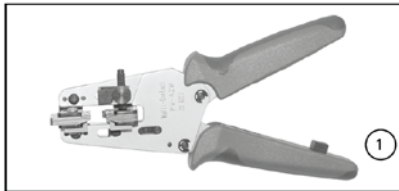

(ill. 1)
Stripping pliers PV-AZM... incl. built-in blade as well as hexagonal screwdriver A/F 2,5mm.

Cable cross section: 1,5 / 2,5 / 4 / 6 mm²

Type: PV-AZM-1.5/6

Order No. 32.6029-156

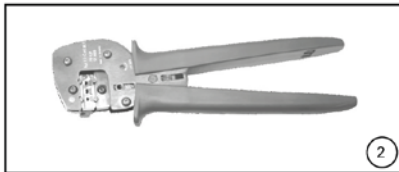

(ill. 2)
Crimping pliers PV-CZM... incl. locator and built-in crimping insert.

Crimping range: 2,5 / 4 / 6 mm² (12 / 10 AWG)

Type: PV-CZM-19100

Order No. 32.6020-19100



(ill. 3)
Open-end spanner PV-MS,
1 Set = 2 pieces

Order No.: 32.6024



(ill. 4)
PV-WZ-AD/GWD socket wrench insert to tighten

Order No. 32.6006

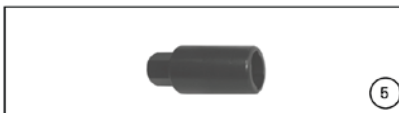

(ill. 5)
PV-SSE-AD4 socket wrench insert to secure

Order No. 32.6026



(ill. 6)
Test plug PV-PST

Order No. 32.6028



(ill. 7)
Open-end spanner A/F 15 mm



(ill. 8)
Torque screwdriver A/F 12 mm

Cable preparation

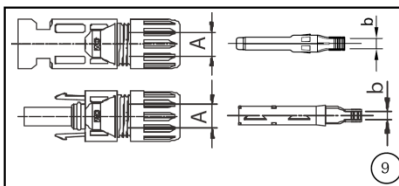

(ill. 9)
Use 14-10AWG (2.5-6mm²) conductor as DC cable.
Dimension **A** 3-6mm, **b** 2.5-6mm²

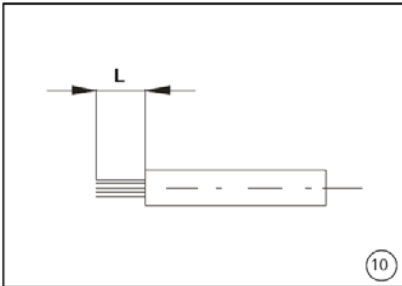

(ill. 10)
Strip the cable end **L** with 6 mm to 7.5 mm of insulation.

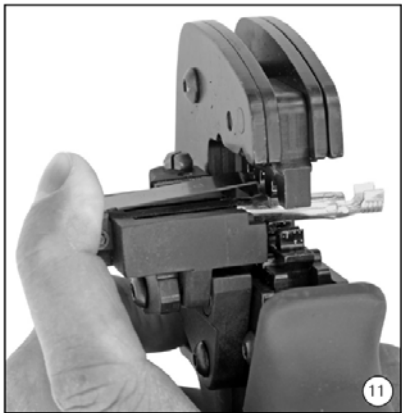

(ill. 11)
Open the clamp (K) and hold. Place the contact in the appropriate cross section range.
Turn the crimp lugs upwards. Release the clamp (K). The contact is fixed.

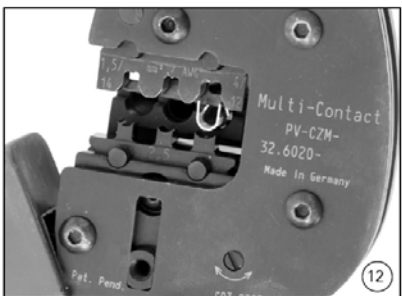

(ill. 12)
Press the pliers gently together until the crimp lugs are properly located within the crimping die.

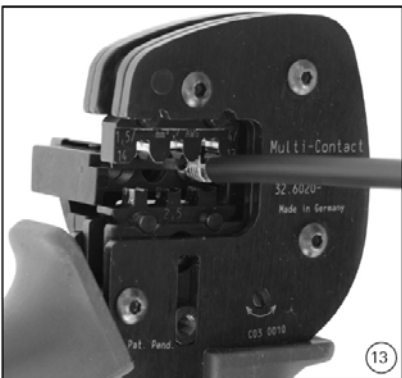

(ill. 13)
Insert the stripped cable end until the insulation comes up against the crimp insert. Completely close the crimping pliers.



(ill. 14)
Visually check the crimp.



(ill. 15)

Insert the crimped-on contact into the insulator of the male or female coupler until it clicks into place. Pull gently on the lead to check that the metal part is correctly engaged.



(ill. 16)

Insert the appropriate end of the test pin into the male or female coupler as far as it will go. If the contact is correctly located, the white mark on the test pin must still be visible.

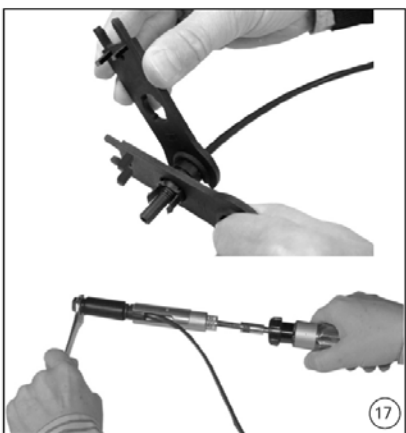

(ill. 17)

Screw up the cable gland hand-tight with the tools PV-MS or tighten the cable gland with the tools PV-WZ-AD/GWD and PV-SSE-AD4.

In both cases: The tightening torque must be appropriate for the solar cables used. Typical values are between 2,5 Nm and 3 Nm.

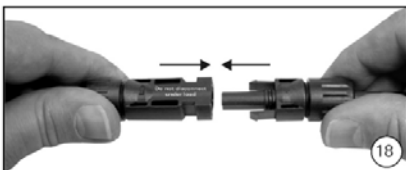

(ill. 18)

Plug the parts of the cable coupler together until they click in place. Check that they have engaged properly by pulling on the cable coupler.

6.4 Communication and Monitoring Device

There are 2 RJ45 plugs in the bottom side of the Omnik inverter as the following figure:

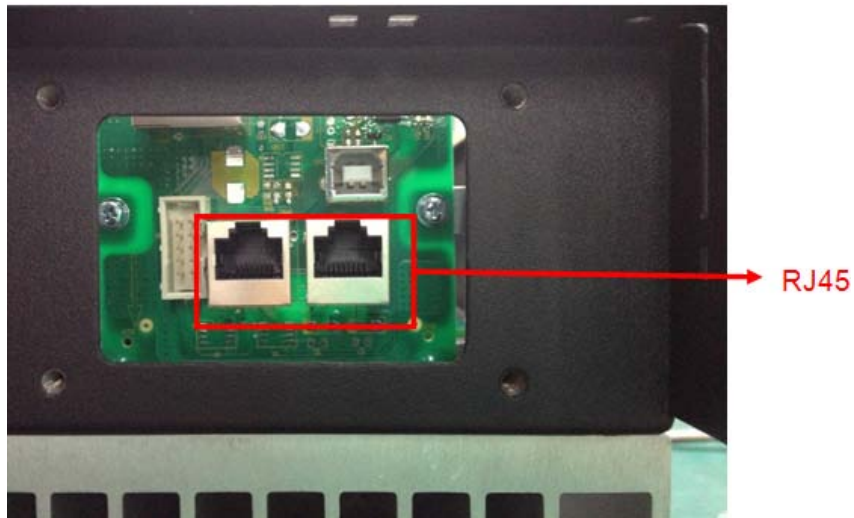

These 2 RJ45 plugs are used for communicating with WiFi kit or GPRS kit to monitor the inverter. Besides they can also be used for communicating with PQD to control the output of the inverter.



Fig. WiFi/GPRS Kit

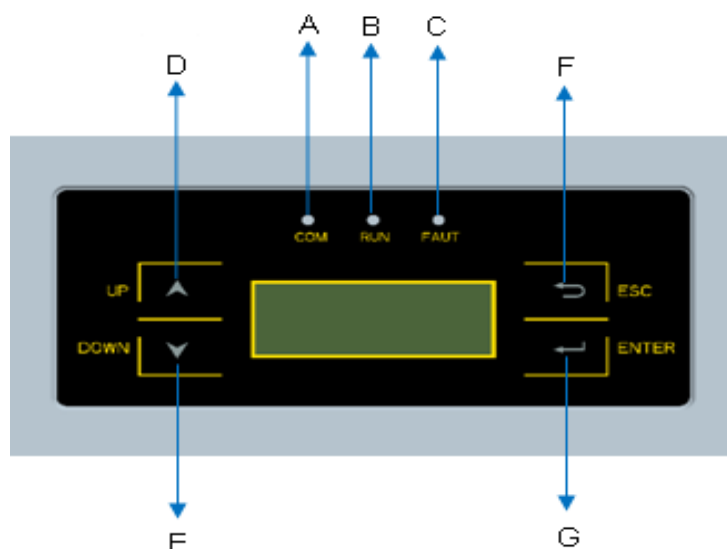

Fig. PQD

You can get more information in the user manual of PQD and WiFi/GPRS kit.

7. Display and Operation

7.1 LCD Panel



Object	Description
A	LED light(Yellow) – COM
B	LED light(Green) – RUN
C	LED light(Red) – FAULT
D	UP key
E	DOWN key
F	ESC key
G	ENTER key

The LCD panel is integrated in the front lid of the inverter, so it is easy for user to check and set the data. In addition, the user can press the function key to illuminate the LCD screen.



NOTICE

Omnik inverter is not an aligned measuring instrument for current, voltage or power consumption. A slight deviation of a few percent points is intrinsic to the system; the results from the inverter cannot be used for grid balance calculations. An aligned meter will be required to make calculations for the utility company.

7.2 Commissioning



NOTICE

The power supply of display module is AC grid, so the screen will not be available until AC is connected.

A minimum available voltage of 150Vdc and a DC power of >30Wdc is required before the inverter starts feeding power to the grid.

AC side: Turn on the AC circuit break and the display module will work.

DC side: Turn on the DC switch.

When the inverter is started for the first time, a menu is displayed to choose language and the country where the inverter installed, English, Dutch and Deutsch are available for display.



NOTICE

You need to confirm that you choose the right country safety to ensure that compliance with local standards.

7.3 Operation

7.3.1 System operation interface

System operation interface 1:

```
Waiting 0 Italy
Power 0W
EToday 0.00kWh
Info Error Set
```

In this interface, the displayed “**Waiting 0**” part will switch along with the system operation status.

The system will have the following status:

1. Waiting status: Display as Waiting XXX, XXX refers to the countdown time, will display 1~3 numbers.
2. Flash status: Display as Flash
3. Fault status: Display as Fault XX, XX refers to error code, will display 1~2 numbers.

Power and **EToday** in this interface will change along with the change of number after system operation.

System operation interface 2:

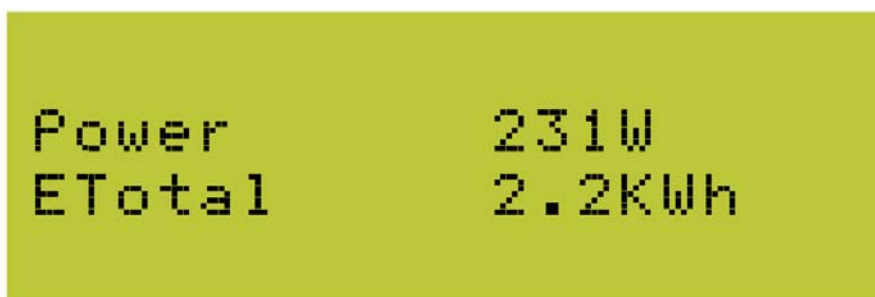

Power and **ETotal** in this interface will change along with the change of number after system operation.

System operation interface 3:

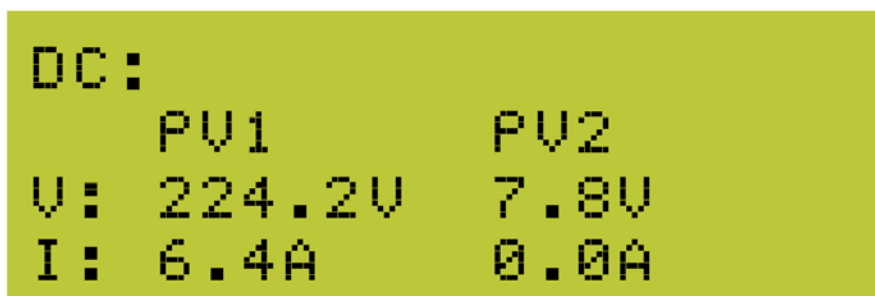

This interface displays the input voltage and current of the 2 input PV panel.

System operation interface 4:

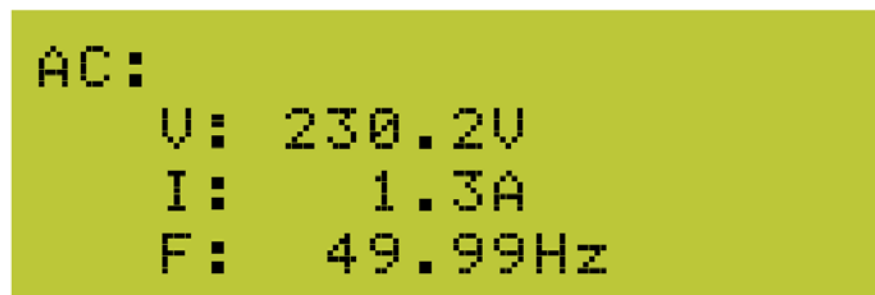

This interface displays the voltage and frequency of grid and the current which inverter outputs to the grid.

System operation interface 5:



This interface displays the WiFi information of the inverter, including WiFi SN and IP address.

7.3.2 Interface introduction

Safety Interface: When choose “**Safety**” by pressing compound key (**ESC+ENTER**) in system operation interface 1 for 3 seconds.

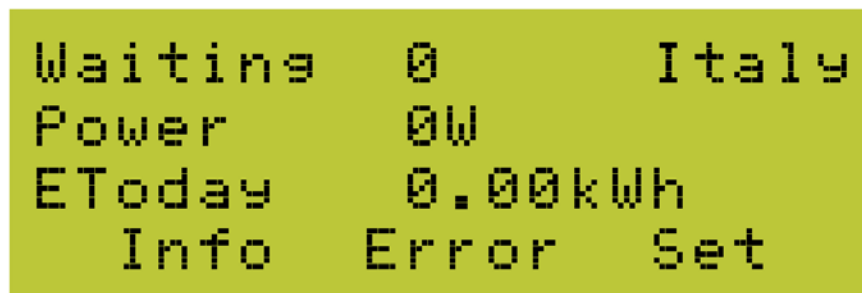

Safety “**Italy**” in the screen flickers. After confirm to enter, password dialog box appears. The default password is “**654321**”.



After entering the password, system will get to the safety selection interface.

Safety selection interface:

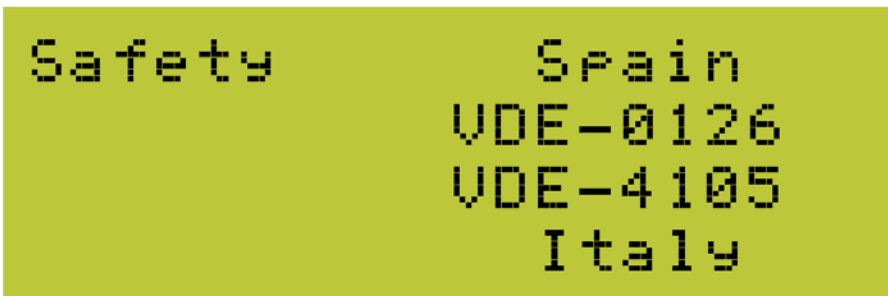

The selected safety information flickers. The selectable safety information as following:

Italy	VDE-4105	VDE-0126	Spain	GREMAIN
Portugal	Belgium	Italy _ S	EnglG83	EnglG59
Austral	China	GerBDEW	Dan mark	Grelsla
Czech	Slovak	Holland	Sweden	Bulgaria
France	Brazil	EngG592	Holl16A	SAfrica

These safety information will be arranged in 4 lines, i.e. there will be 4 safety information displayed in the same interface.

Info Interface:

You can choose “Info” by **UP** and **DOWN** key in system operation interface 1

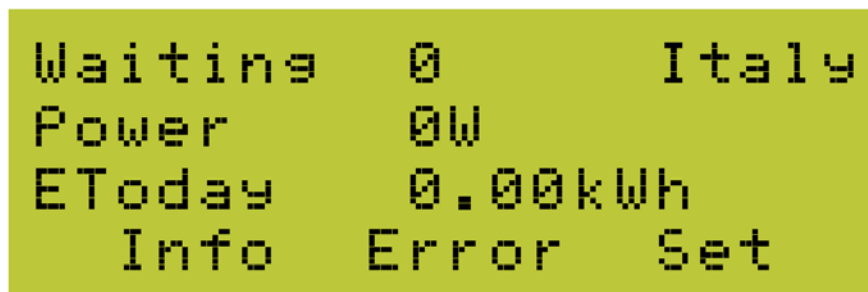

While “Info” flickers. Confirm to enter Info mode. There will be 7 interfaces in the Info mode.

1. PV panel information:

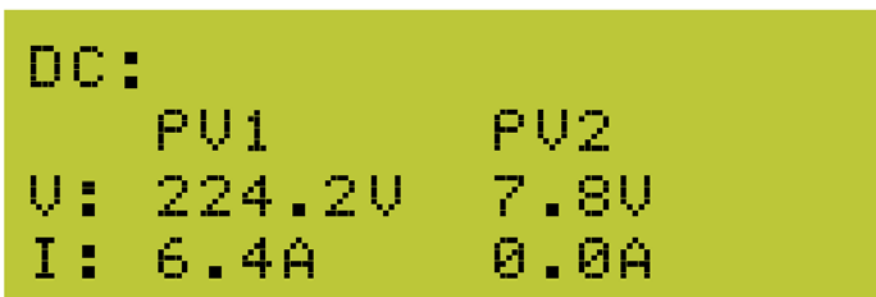

2. AC grid information:

```
AC:
  U: 230.2V
  I:  1.3A
  F: 49.99Hz
```

3. Inverter's Model information:

```
Model:
      5000TL2
```

4. Inverter's SN Information:

```
SN:
    DEDN50201306TS27
```

5. Inverter's master CPU information:

```
Master CPU:
  U98  Build00
```

6. Inverter's slave CPU information:

```
Slave CPU:  
V0.0.0Build00
```

7. Inverter's display module version information:

```
LCD CPU:  
V0.0.0Build00
```

Error record display interface:

You can choose “**Error**” by **UP** and **DOWN** key in system operation interface 1

```
Waiting 0 Italy  
Power 0W  
EToday 0.00kWh  
Info Error Set
```

While “**Error**” flickers, confirm to enter the Error record mode.

Interface number of the Error record mode is unfixed; it ranges from 0 to 9 interfaces.

No error record interface:

```
Error Info  
No Error Record
```

Recent error record interface:

```
Page0      23-7-2013
E14        6-4-11
Master Grid Volt Fau
```

Earliest error record interface:

```
Page10    0 -0 -2000
E0        0 -0 -0
SCI Lose
```

Set mode:

You can choose “**Set**” by **UP** and **DOWN** key in system operation interface 1

```
Waiting 0 Italy
Power 0W
EToday 0.00kWh
Info Error Set
```

While “**Set**” flickers, confirm to enter the Set mode.

The Set mode is operated with 2 levels of menu. There are five items in the sub-menu, Time, Data, Password, Language and WiFi. The items are shown as following picture.

```
Set Menu    Date
             Time
             Password
             Language
```

Choose the item which needs adjustment by **UP** and **DOWN** key in the sub-menu. The flickering one is the selected item.

Setting Language:

In the Set mode, choose Language by Up and Down key (as shown in the picture)

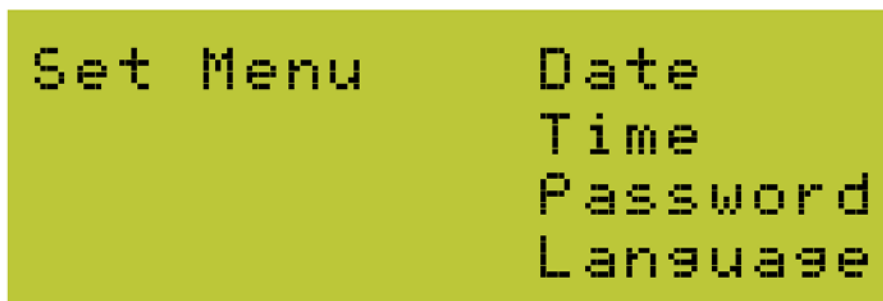

While “**Language**” flickers, confirm to enter the language option list.



Choose the target language, the corresponding language flickers. English, Dutch and Deutsch are available for displaying. Click **ENTER** to save data and back to prior menu.

Changing Password:

In the Set mode, choose “**Password**” by **UP** and **DOWN** key as shown in the picture.

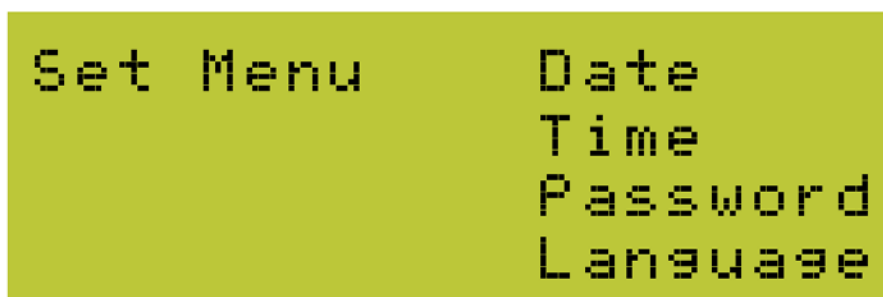

While “**Password**” flickers, confirm to enter the password modified interface.



Input 6 figure passwords, check correctness and enter the modified mode



Save password after the end of input

Back to two-level menu mode after saving the password

Setting Time:

In the Set mode, choose “**Time**” by **UP** and **DOWN** key as shown in the picture.

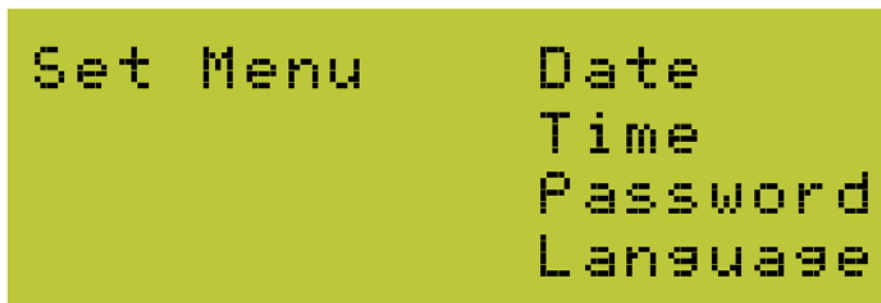

While “**Time**” flickers, confirm to enter the inverter time setting mode.

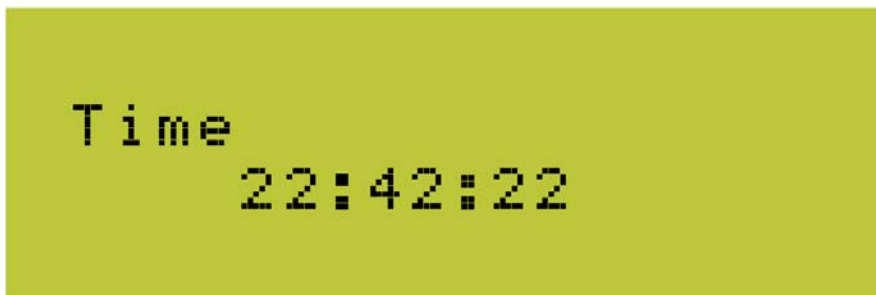

There are hour, minute and second displayed in the time setting mode. Use ENTER key to choose the one you want modify and **UP/DOWN** key to change the value.

Setting Date:

In the Set mode, choose “**Date**” by **UP** and **DOWN** key as shown in the picture.

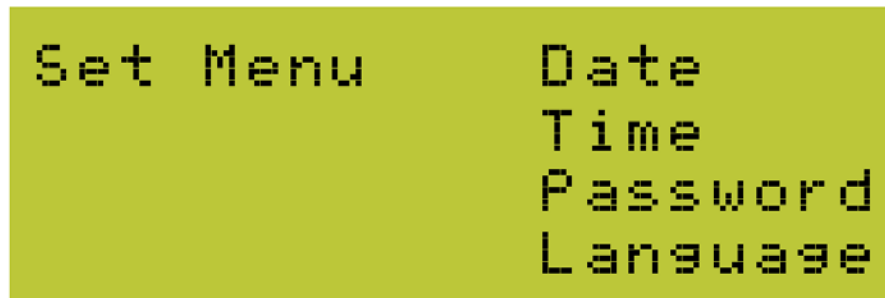

While “**Date**” field flickers, confirm to enter the inverter Date Setting mode

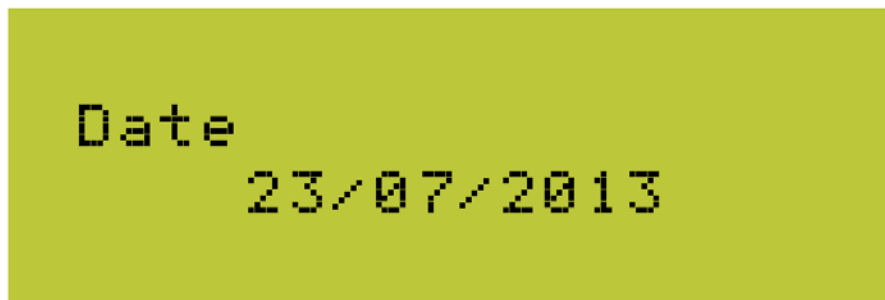

There are day, month and year displayed in the date setting mode, Set date by **Up/Down** key. Confirm to enter the next setting data, the sequence is day/month/year. After setting year, back to the two-level menu mode.

7.4 State Information

State	Display	State information
Wait	Waiting	Initialization & waiting
	Reconnects	Reconnect
	Checking's	Checking
Normal	Normal	Normal state
Fault	Current Fault	GFCI failure oversized leakage current
	Master Grid Freq Fault	Grid frequency failure
	Master Grid Freq Fault	Grid voltage failure
	PV Voltage Fault	Input voltage too high
	Over Temp Fault	Temperature abnormal
	Isolation Fault	Isolation failure
	Relay1 Fault Relay2 Fault	Output relay failure
	Current DC Offset	Output DC injection too high
	Eeprom Fault	EEPROM problem
	SCI Lose	Serial communication interface failure
	Hole Sense Device Fault	Output AC sensor abnormal
GFCI Failure	GFCI testing device abnormal	
Flash	F/W Updating	Update

About the further information for each fault, please reference to chapter “10.Troubleshooting”.

8. Communication Setting

8.1 GPRS Card

GPRS card is an optional device. If your inverter had installed the GPRS card, please go to **8.3. Register on monitoring website.**

After unpacking the box, please check the parts according to the below list. Contact the manufacturer immediately when you find any damage, missing or wrong model.

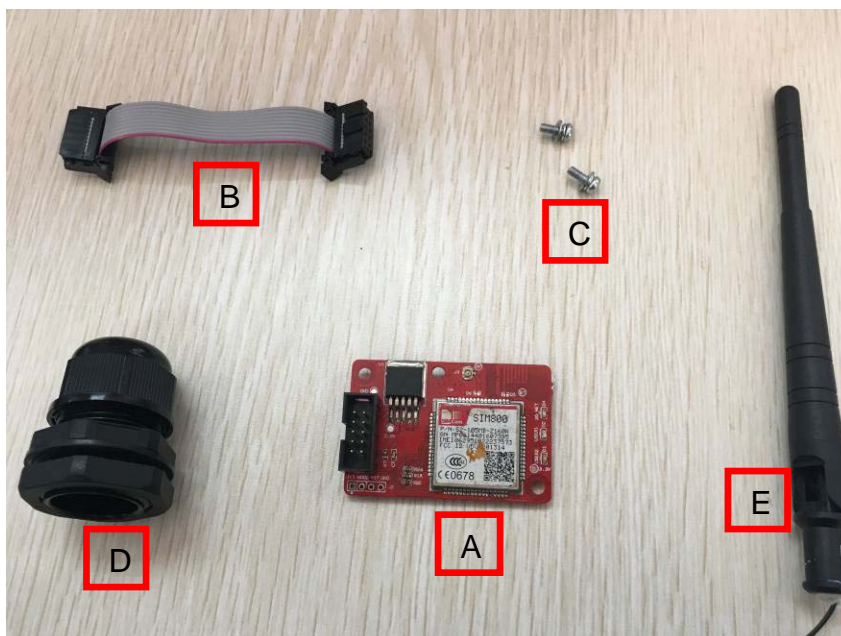

No.	Name	Quantity
A	PV data collector	1
B	Data line	1
C	Screw	2
D	Connector	1
E	GPRS antenna	1

Fig. GPRS card

Omnik provide 2 kinds of GPRS cards. One is a standard GPRS card and the other one has a card slot.

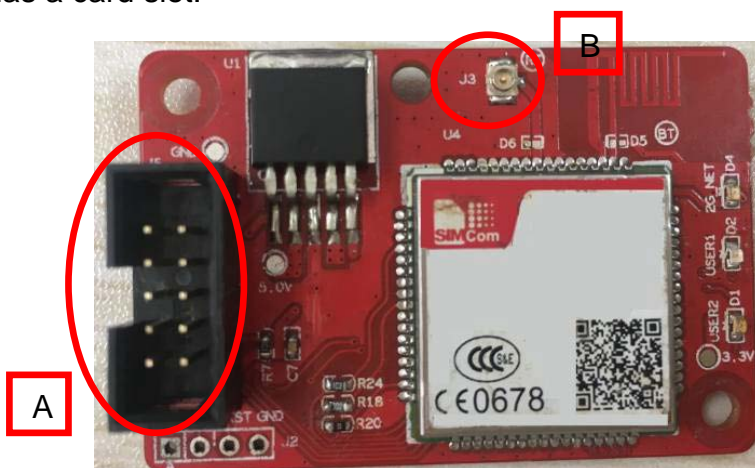

No.	Name
A	10 pin connector
B	I-PEX interface

Fig. Standard GPRS card

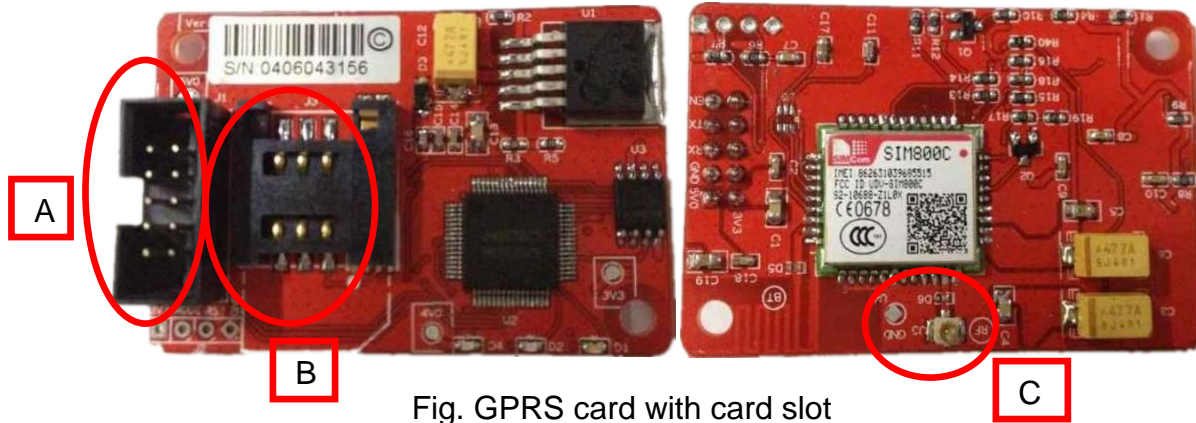

Fig. GPRS card with card slot

No.	Name
A	10 pin connector
B	SIM card slot
C	I-PEX Interface

The serial number is shown as below.



Fig. Serial Number

8.2 Installation of communication card

Warning: Before installing the GPRS card to inverter, you must turn off both the AC side and DC side of inverter to make sure personal safety.



Fig. Dismantle the communication box

Unscrew the four screws on the interface panel with the screwdriver as shown in Picture above and keep the screws aside.



Fig. Communication box and connector

The standard connector has two holes. Use the single-hole connector to take place of the double-hole connector.



Fig. Single-hole connector

Insert the GPRS antenna through the gland and screw the hex nut with a torque of 2.0 N.m.



Fig. Insert the GPRS antenna

Make the line through the hole of GPRS card and connect it into the I-PEX interface. Then screw the two screws and fix the GPRS card.



Fig. Connect the GPRS antenna



Fig. Fix the GPRS card

While using the second kind of GPRS card, just insert the SIM card into the card slot. Then connect two sides of the data line to GPRS card and inverter. Don't forget turn the switch up as shown below.



Fig. Connect the data line

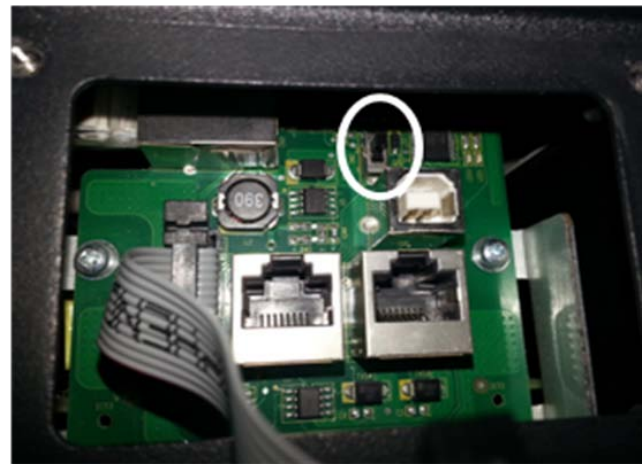

Fig. Turn the switch up

Install the communication box back to the inverter. While the installation is completed, Antenna can be turned in 360 degrees.



Fig. Complete the installation

8.3 Register on monitoring website

The PV monitoring system of Omnik is supported by: IE8, Firefox, Chrome, and Safari. Login the website <http://www.omnikportal.com>, click register to enter the user registration page, follows the requirements for registration; please fill in the information for register. After successful registration, enter the mailbox and activity the account, then to complete the registration.



Fig. Click and enter the register interface

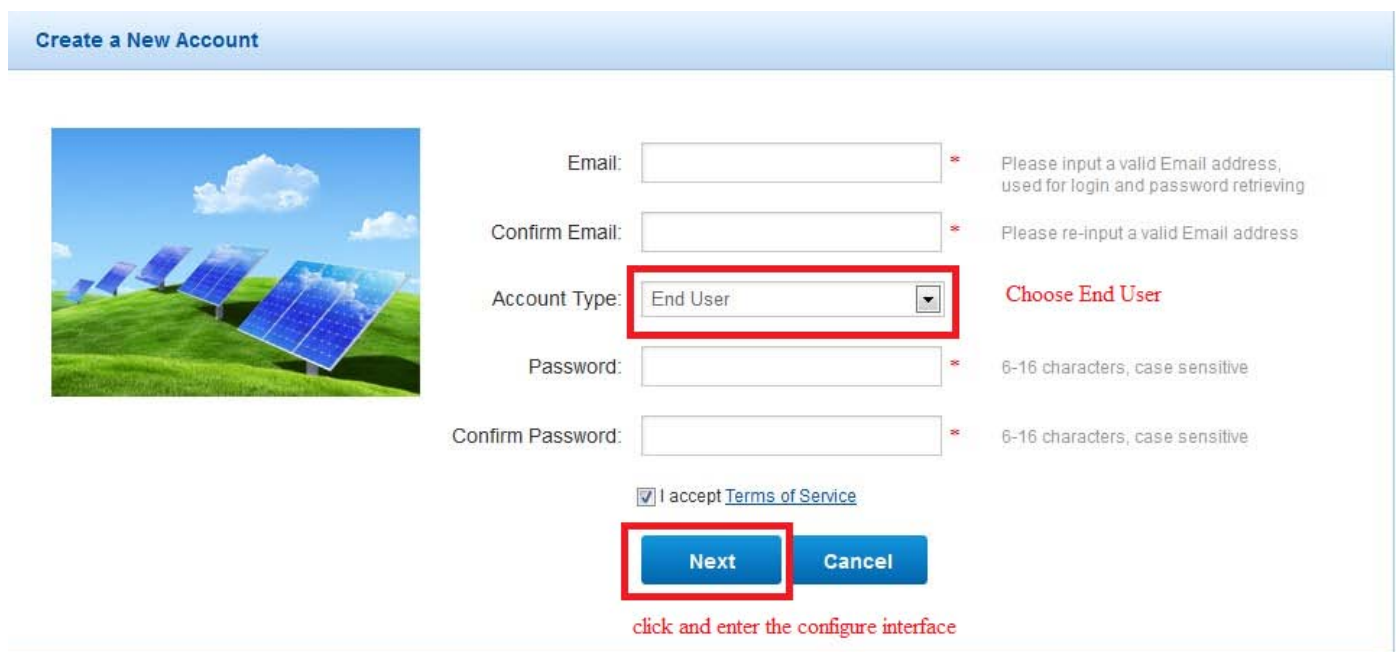

Fig. Choose the account type

Remarks: please read the < Omnik service agreement > carefully, the enclosure is the cost list for all the countries; please choose your operators **End User** means the final user

“*” you must fill it

Site Name *Maximum 20 Letters

Upload Image **Click and Choose the Picture**



Click "OK" to Save pic

Country *

Province/State *

City *

Street [Locate Your Site On Map](#)

ZIP Code

Timezone

Choose your Country Format

Temperature Unit

System Size(kWp) *

Fig. Fill in the power station information

Temperature Unit

System Size(kWp)

Feed-in Tariff(FIT)

Panel Type

Inverter Type

Description

Make This Site Public

Registration **Fill in WiFi Card S/N Code, see picture 4-1**

Datalogger S/N

Installer

Contact

Name

Phone

Finish the register

Fig. Fill in the power station information

After the register, you may enter next chapter **8.4 Login Monitoring System**.

8.4 Login monitoring System

After the successful register and account activation, open the login interface as below. Input the correct email and code. Enter the PV monitoring system. Then you can monitor and manage the power station.



Fig. Input the email and code

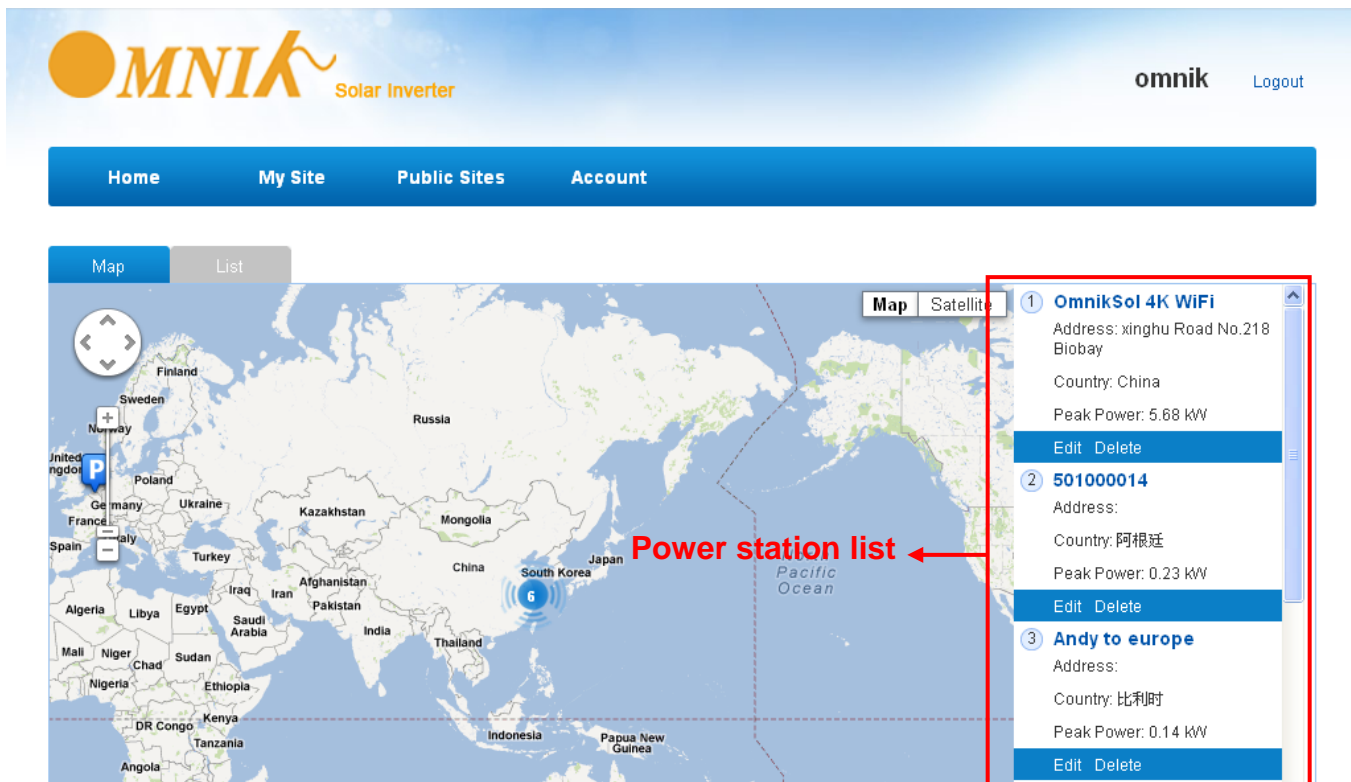

Fig. User interface



Fig. List of power station

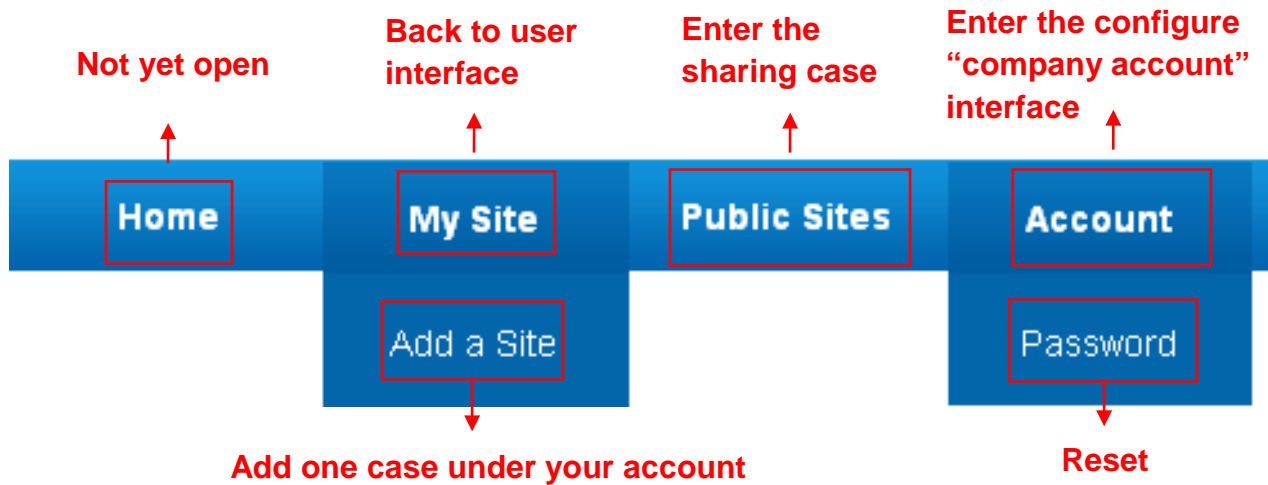

Fig. Navigation Bar

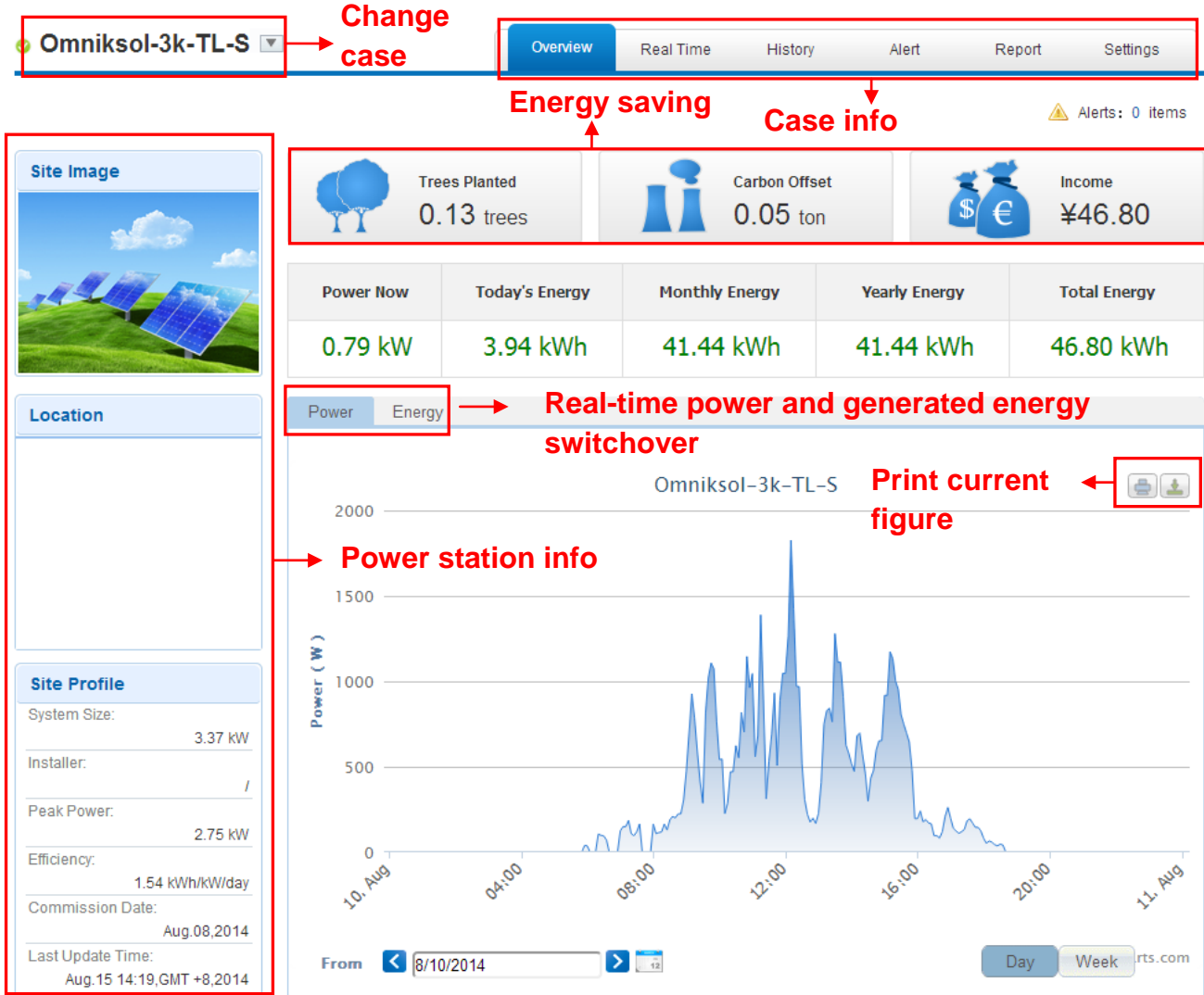

Fig. Main interface of Power Station

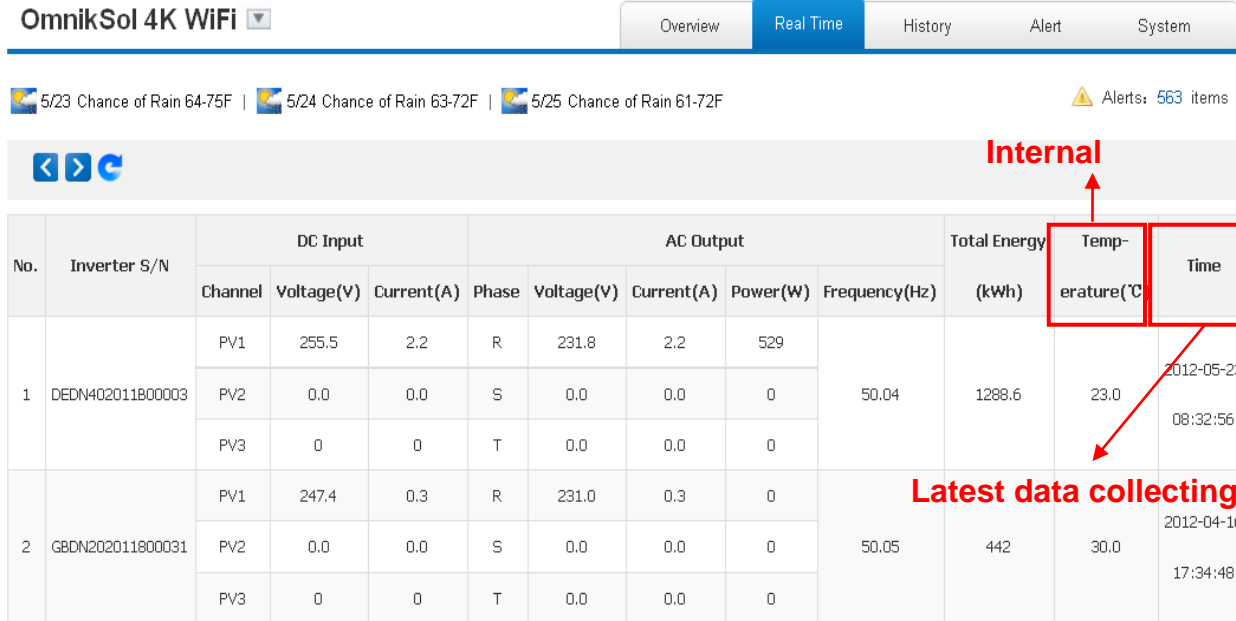

Fig . Real Time Interface

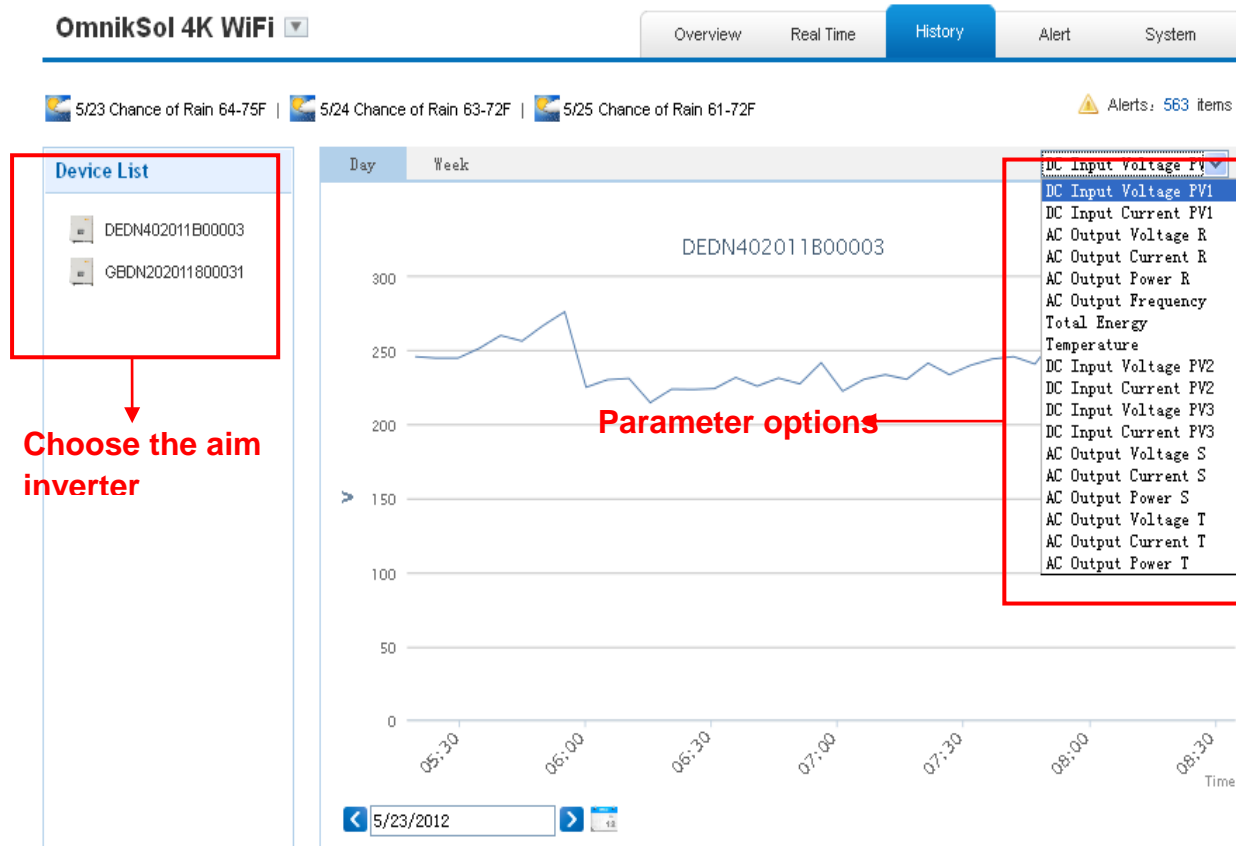

Fig. History Interface

OmnikSol 4K WiFi

Overview Real Time History **Alert** System

5/23 Chance of Rain 64-75F | 5/24 Chance of Rain 63-72F | 5/25 Chance of Rain 61-72F

Alerts: 563 items

Select: View All View All Page 1 of 57

Inverter	Inverter Manufacturer	Information	Code	Alert Time	Status	View History
DEDN202011800912	Default	Utility Loss	F09	3/8/2012 16:10:38	Unhandled	History
GBDN202011800031	Default	Utility Loss	F09	2/11/2012 11:9:3	Unhandled	History
GBDN202011800031	Default	Utility Loss	F09	2/13/2012 12:56:36	Unhandled	History
DEDN202011800912	Default	Utility Loss	F09	3/8/2012 16:11:38	Unhandled	History
GBDN202011800031	Default	Utility Loss	F09	2/11/2012 11:14:7	Unhandled	History
GBDN202011800031	Default	Utility Loss	F09	2/13/2012 13:1:42	Unhandled	History
GBDN202011800031	Default	Utility Loss	F09	2/11/2012 11:19:10	Unhandled	History
GBDN202011800031	Default	Utility Loss	F09	2/13/2012 13:6:38	Unhandled	History
GBDN202011800031	Default	Utility Loss	F09	2/11/2012 11:24:14	Unhandled	History
GBDN202011800031	Default	Utility Loss	F09	2/13/2012 13:11:42	Unhandled	History

Fig. Alert Interface

OmnikSol 4K WiFi

Overview Real Time History Alert **System**

5/23 Chance of Rain 64-75F | 5/24 Chance of Rain 63-72F | 5/25 Chance of Rain 61-72F

Alerts: 563 items

Site Device

Site Name OmnikSol 4K WiFi *

Upload Image Default.jpg



OK

Fig. System Setting Interface

Site **Device**

	Datalogger S/N	Datalogger Name	Manufacturer	Operate
1	601230010		Unfound	Delete Edit
2	300000012	网关1	Unfound	Delete Edit

Add

Datalogger S/N

OK

Fig. Add serial number

8.5 WiFi card

WiFi card is an optional device. If your inverter had installed the WiFi card, please go to **8.6. Network Settings**. If your inverter had not installed the WiFi card, please go to **8.2. Installation of communication card** first, then go to **8.6. Network Settings**.

After unpacking the box, please check the parts according to the below list. Contact the manufacturer immediately when you find any damage, missing or wrong model.

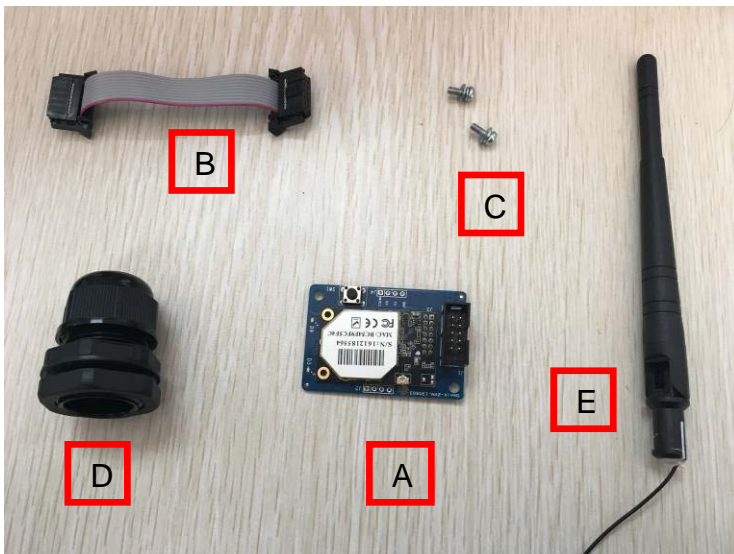

No.	Name	Quantity
A	PV data collector	1
B	Data line	1
C	Screw	2
D	Connector	1
E	WiFi antenna	1

Fig. WiFi card

WiFi card is shown as below:

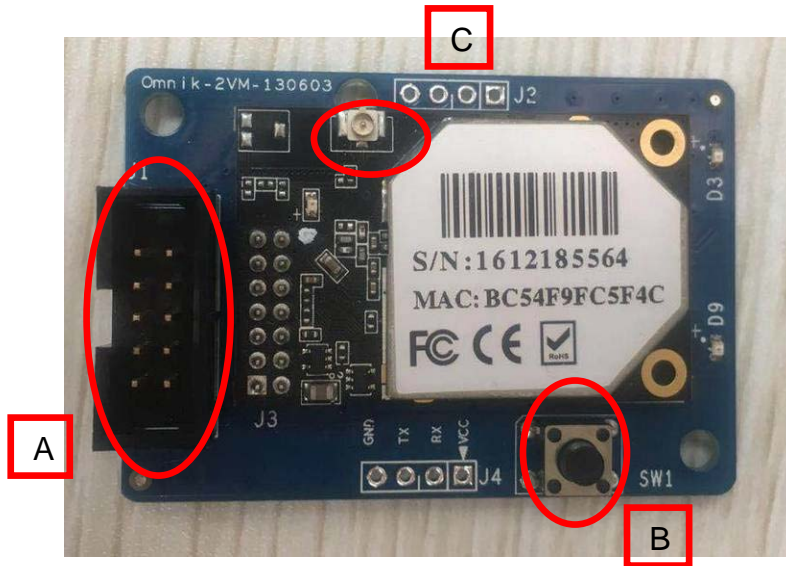

No.	Name
A	10 pin connector
B	Reset Button
C	I-PEX Interface

Fig. WiFi card



Fig. Serial Number

8.6 Network Settings

- 1) Prepare a computer or device, e.g. tablet PC and smart phone that enables WiFi
- 2) Obtain an IP address automatically
 - Open Wireless Network Connection Properties, double click **Internet Protocol Version 4(TCP/IPv4)**
 - Select Obtain an IP address automatically, and **click OK**

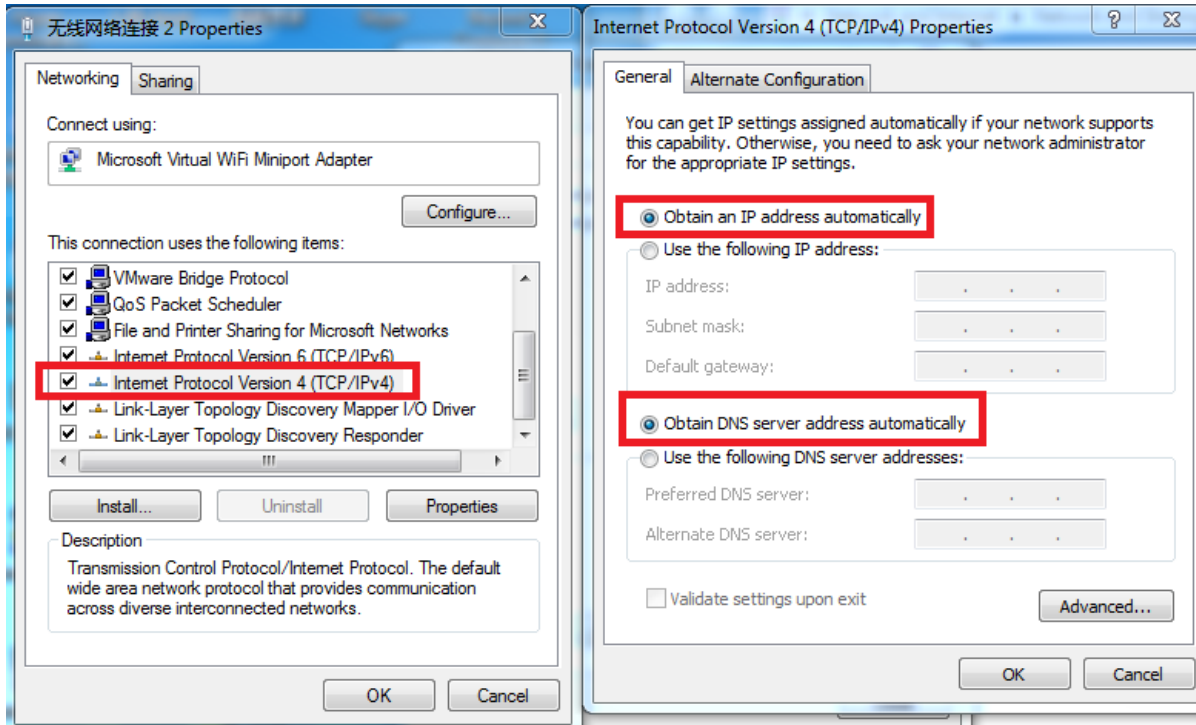

- 3) Open wireless network connection and click **View Wireless Networks**
 Select wireless network of the data logging module, no passwords required as default.
 The network name consists of **AP** and the **serial number** of the product. Then click **Connect**.

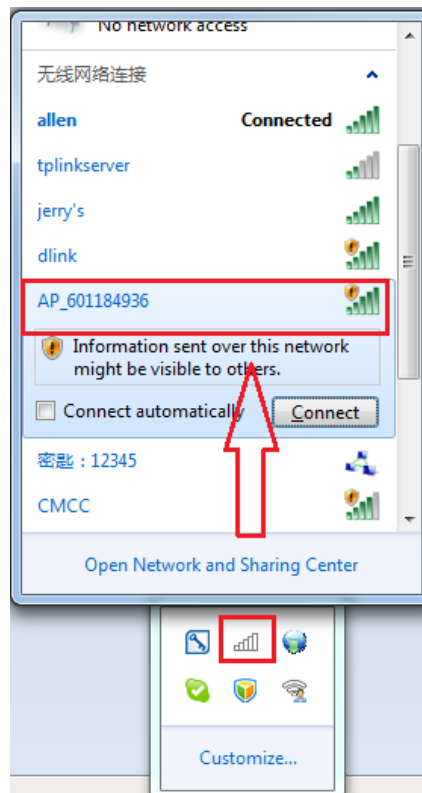

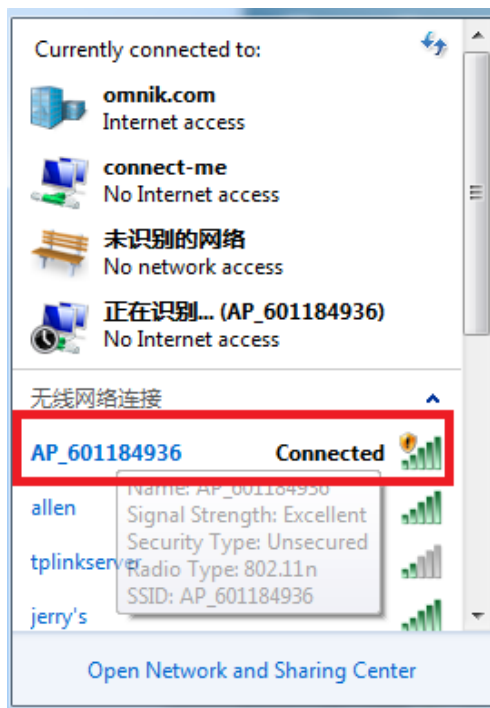

Connection successful

Notice: If AP_ (serial number of product) is not available in the wireless network list, there may be problems in the connection or setting of data logging module. Please check if the WiFi had installed ok, and inverter has been powered on.

Before troubleshooting, please inquire with your inverter installer whether you are allowed to remove the cover of the inverter to trouble shoot the module. If not allowed, please contact customer service.

4) Set parameters of WiFi module

(a) Open a web browser, and enter 10.10.100.254(the Default IP address of WiFi card, you may set domain name access, please see the picture 6-14), then fill in username: **admin** and password: **admin**, both of which are admin as default.

Recommended browsers: Internet Explorer 8+, Google Chrome 15+, Firefox 10+

Note:

- ① *If the IP address shows **0.0.0.0** (factory value) on your LCD (Picture5-4-1), it is not a correct address. There are 2 cases show 0.0.0.0:*
 - *Not connect router rightly, you need reset to connect you router to make it right*
 - *Card loose in the inverter, please check your inverter, see chapter 4.:WiFi Card Installation*
- ② *The default username & password :admin, admin, we suggest modify the username & password:*
Step: choose Account, input your username &password.

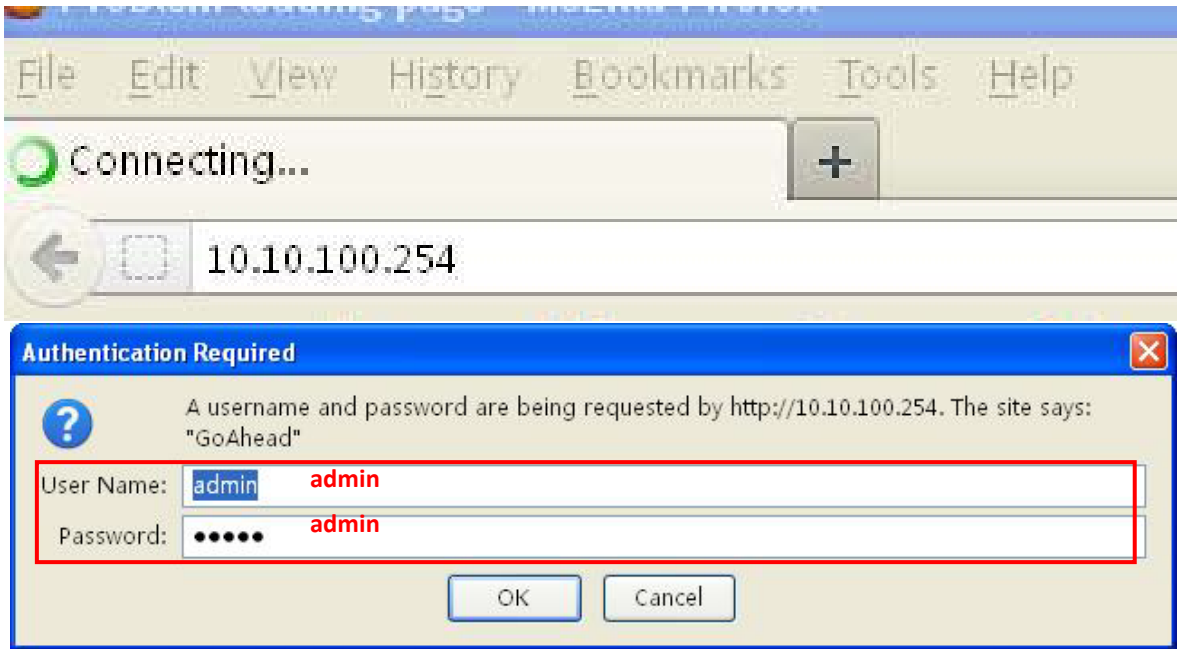

(b) In the configuration interface of WiFi module, you can view general information of the module.

Follow the setup wizard to start quick setting.

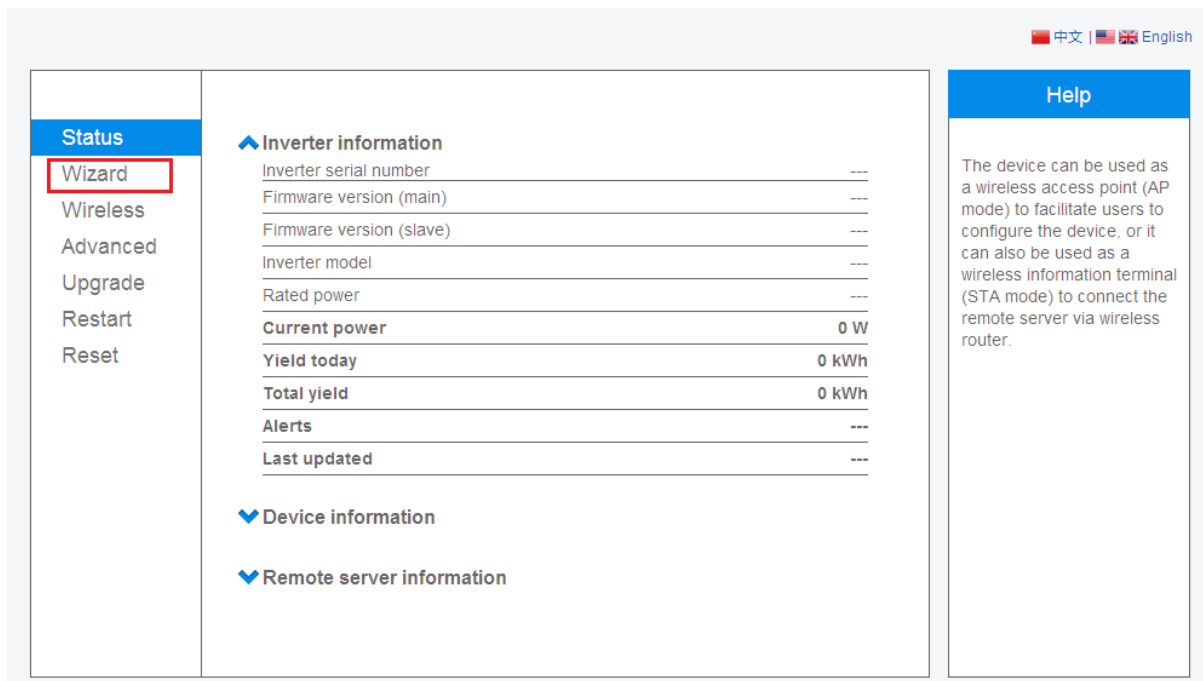

Click **Wizard** to start

Status	<p>Dear user:</p> <p>Thank you for choosing our device. Next, you can follow the setup wizard to complete the network setting step by step; or you can select the left menu for detailed setting.</p> <p>★Note: Before setting, please make sure that your wireless network is working.</p> <p>Start</p> <p>1 2 3 4 5</p>	<p>Help</p> <p>The setup wizard will assist you to complete the device setting within one minute.</p>
Wizard		
Wireless		
Advanced		
Upgrade		
Restart		
Reset		

Click **Start** to continue

Status	<p>Please select your current wireless network:</p> <p>★Note: When RSSI of the selected WiFi network is lower than 15%, the connection may be unstable, please select other available network or shorten the distance between the device and router.</p> <p>Refresh</p> <p>Add wireless network manually:</p> <p>Network name (SSID) <input type="text"/> (Note: case sensitive)</p> <p>Encryption method <input type="text" value="Disable"/></p> <p>Back Next</p> <p>1 2 3 4 5 6</p>	<p>Help</p> <p>This step will help to connect the device to your desired WLAN. If you do not find your wireless router on the left list, please refresh several times or add it manually.</p> <p>Please check your wireless router for the right encryption method and encryption algorithm.</p> <p>If your wireless router does not broadcast SSID, please add a wireless network manually.</p>
Wizard		
Wireless		
Advanced		
Upgrade		
Restart		
Reset		

Click **Refresh** to search available wireless networks

Status

Wizard

Wireless

Advanced

Upgrade

Restart

Reset

Please select your current wireless network:

Site Survey

SSID	BSSID	RSSI	Channel
<input type="radio"/> AP_602558269	88:8b:5d:00:00:e0	60%	1
<input type="radio"/> AP_601777777	ac:cf:23:12:1e:98	60%	1
<input type="radio"/> AP_SOLAR_PORTAL_M2M_20120615	28:c6:8e:a3:94:6a	70%	1
<input type="radio"/> AP_602822991	ac:cf:23:10:7c:cc	60%	3
<input checked="" type="radio"/> yingzhendlink	ec:6c:9f:04:b3:2c	65%	3
<input type="radio"/> AP_901000415	ac:cf:23:ff:34:2c	100%	3
<input type="radio"/> AP_501201091	ac:cf:23:10:84:04	20%	3
<input type="radio"/> AP_SOLAR_PORTAL_M2M_20120615	a0:f3:c1:ac:33:06	81%	8
<input type="radio"/> NETGEAR35	28:c6:8e:18:ca:55	91%	10
<input type="radio"/> AP_300000005	ac:cf:23:10:f3:bc	44%	10
<input type="radio"/> AP_603060815	ac:cf:23:10:f7:0c	39%	10

★Note: When RSSI of the selected WiFi network is lower than 15%, the connection may be unstable, please select other available network or shorten the distance between the device and router.

Refresh

Add wireless network manually:

Network name (SSID)
(Note: case sensitive)

Encryption method

Encryption algorithm

Back
Next

1
2
3
4
5
6

Help

This step will help to connect the device to your desired WLAN. If you do not find your wireless router on the left list, please refresh several times or add it manually.

Please check your wireless router for the right encryption method and encryption algorithm.

If your wireless router does not broadcast SSID, please add a wireless network manually.

Select the wireless network you need to connect, then click **Next**

Notice:

- ① If the signal strength (RSSI) of the selected network is <10%, which means unstable connection, please adjust the antenna of the router, or use a repeater to enhance the signal.
- ② We recommend router setting:
 - Security setting: WPA2-personal
 - Encryption type: AES

<ul style="list-style-type: none"> Status Wizard Wireless Advanced Upgrade Restart Reset 	<p>Please enter the wireless network password:</p> <div style="border: 2px solid red; padding: 10px; margin: 10px auto; width: 80%;"> <p>Password (8-64 bytes) (Note: case sensitive)</p> <input type="password" value="••••••••"/> <p>Re-enter password</p> <input type="password" value="••••••••"/> <p><input type="checkbox"/> Show Password</p> </div> <p>Connecting ••</p> <div style="margin: 10px auto; width: 100px; text-align: center;"> <input type="button" value="Back"/> <input style="border: 2px dashed red;" type="button" value="Next"/> </div> <div style="margin-top: 20px;"> <p style="text-align: center;">1 2 3 4 5</p> <hr style="width: 100%; border: 1px solid blue;"/> </div>	Help
		<p>Please make sure you have entered the correct password.</p>

Enter the password for the selected network, then click **Next**

<ul style="list-style-type: none"> Status Wizard Wireless Advanced Upgrade Restart Reset 	<p>Please fill in the following information:</p> <div style="margin: 10px auto; width: 80%;"> <p>Obtain an IP address automatically Enable ▼</p> <p>IP address <input type="text" value="0.0.0.0"/></p> <p>Subnet mask <input type="text" value="0.0.0.0"/></p> <p>Gateway address <input type="text" value="0.0.0.0"/></p> <p>DNS server address <input type="text"/></p> </div> <div style="margin: 10px auto; width: 100px; text-align: center;"> <input type="button" value="Back"/> <input style="border: 2px dashed red;" type="button" value="Next"/> </div> <div style="margin-top: 20px;"> <p style="text-align: center;">1 2 3 4 5</p> <hr style="width: 100%; border: 1px solid blue;"/> </div>	Help
		<p>Most systems support the function of DHCP to obtain IP address automatically. Please select disable and add it manually if your router does not support such function.</p>

Select **Enable** to obtain an IP address automatically, then click **Next**

Notice:

- ① Turn off the firewall of the router
- ② Make sure the DHCP function of the router is enable

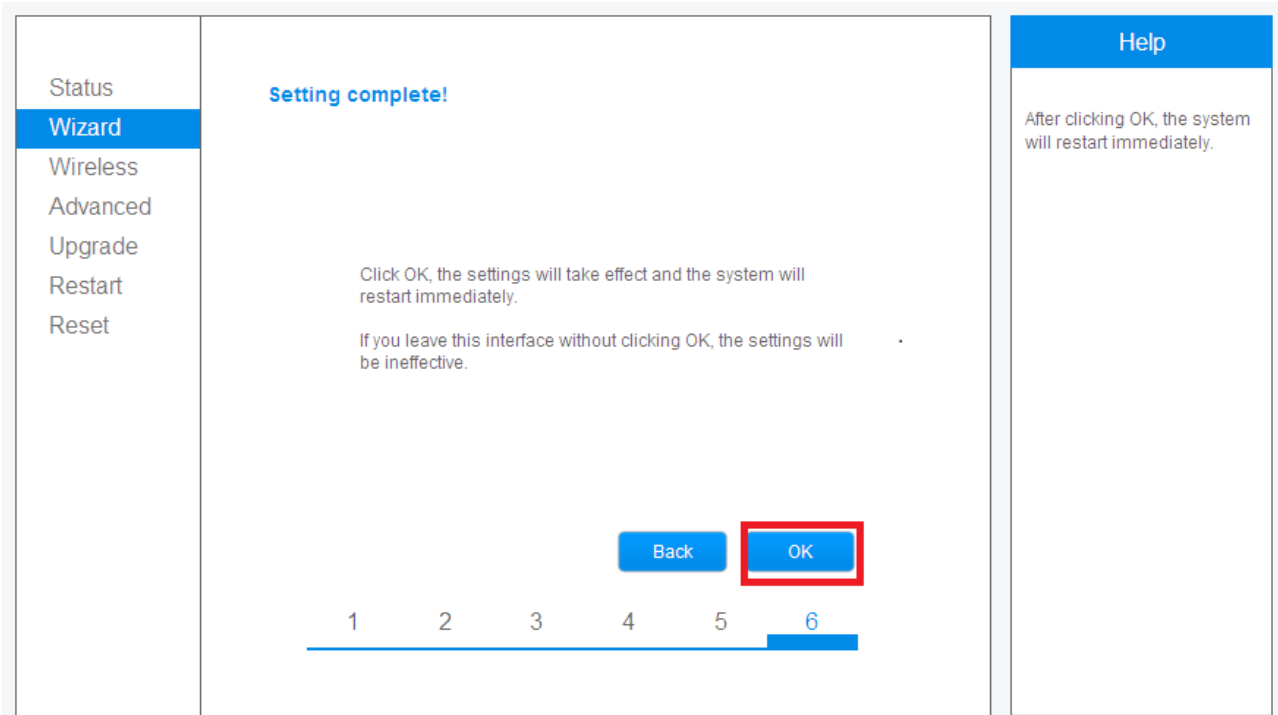

If setting is complete, the above page will display. Click **OK** to restart.



If setting is complete, the above page will display.

After your WiFi card set ok and get IP address from your router for example: 192.168.16.8, (You may see the IP address from inverter)

Input: <http://192.168.16.8/> will display the following page:

Status	<p>▲ Inverter information</p> <table border="1"> <tr><td>Inverter serial number</td><td>DEIN202011600198</td></tr> <tr><td>Firmware version (main)</td><td>GB1-V1.0-0049-4</td></tr> <tr><td>Firmware version (slave)</td><td>V1.6-0020</td></tr> <tr><td>Inverter model</td><td>omnik2000tl</td></tr> <tr><td>Rated power</td><td>2000 W</td></tr> <tr><td>Current power</td><td>0 W</td></tr> <tr><td>Yield today</td><td>0 kWh</td></tr> <tr><td>Total yield</td><td>4.9 kWh</td></tr> <tr><td>Alerts</td><td>F09</td></tr> <tr><td>Last updated</td><td>1 Min Ago</td></tr> </table> <p>▲ Device information</p> <table border="1"> <tr><td>Device serial number</td><td>901000414</td></tr> <tr><td>Firmware version</td><td>H4.01.38Y1.0.07W1.0.05(20130605_4)</td></tr> <tr><td>Wireless AP mode</td><td>Enable</td></tr> <tr><td> SSID</td><td>AP_901000414</td></tr> <tr><td> IP address</td><td>10.10.100.254</td></tr> <tr><td> MAC address</td><td>AC:CF:23:FF:33:2C</td></tr> <tr><td>Wireless STA mode</td><td>connect router,STA will enable <input checked="" type="checkbox"/> Enable</td></tr> <tr><td> Router SSID</td><td>yingzhendlink</td></tr> <tr><td> Signal Quality</td><td>55%</td></tr> <tr><td> IP address</td><td>get IP from router <input checked="" type="checkbox"/> 192.168.1.112</td></tr> <tr><td> MAC address</td><td>AC:CF:23:FF:33:2D</td></tr> </table> <p>▲ Remote server information</p> <table border="1"> <tr><td>Remote server A</td><td>connect remote server ok <input checked="" type="checkbox"/> Pingable</td></tr> <tr><td>Remote server B</td><td>Pingable</td></tr> <tr><td>Remote server C</td><td>Pingable</td></tr> </table>	Inverter serial number	DEIN202011600198	Firmware version (main)	GB1-V1.0-0049-4	Firmware version (slave)	V1.6-0020	Inverter model	omnik2000tl	Rated power	2000 W	Current power	0 W	Yield today	0 kWh	Total yield	4.9 kWh	Alerts	F09	Last updated	1 Min Ago	Device serial number	901000414	Firmware version	H4.01.38Y1.0.07W1.0.05(20130605_4)	Wireless AP mode	Enable	SSID	AP_901000414	IP address	10.10.100.254	MAC address	AC:CF:23:FF:33:2C	Wireless STA mode	connect router,STA will enable <input checked="" type="checkbox"/> Enable	Router SSID	yingzhendlink	Signal Quality	55%	IP address	get IP from router <input checked="" type="checkbox"/> 192.168.1.112	MAC address	AC:CF:23:FF:33:2D	Remote server A	connect remote server ok <input checked="" type="checkbox"/> Pingable	Remote server B	Pingable	Remote server C	Pingable	Help
Inverter serial number	DEIN202011600198																																																	
Firmware version (main)	GB1-V1.0-0049-4																																																	
Firmware version (slave)	V1.6-0020																																																	
Inverter model	omnik2000tl																																																	
Rated power	2000 W																																																	
Current power	0 W																																																	
Yield today	0 kWh																																																	
Total yield	4.9 kWh																																																	
Alerts	F09																																																	
Last updated	1 Min Ago																																																	
Device serial number	901000414																																																	
Firmware version	H4.01.38Y1.0.07W1.0.05(20130605_4)																																																	
Wireless AP mode	Enable																																																	
SSID	AP_901000414																																																	
IP address	10.10.100.254																																																	
MAC address	AC:CF:23:FF:33:2C																																																	
Wireless STA mode	connect router,STA will enable <input checked="" type="checkbox"/> Enable																																																	
Router SSID	yingzhendlink																																																	
Signal Quality	55%																																																	
IP address	get IP from router <input checked="" type="checkbox"/> 192.168.1.112																																																	
MAC address	AC:CF:23:FF:33:2D																																																	
Remote server A	connect remote server ok <input checked="" type="checkbox"/> Pingable																																																	
Remote server B	Pingable																																																	
Remote server C	Pingable																																																	
<p>Wizard</p> <p>Wireless</p> <p>Advanced</p> <p>Upgrade</p> <p>Restart</p> <p>Reset</p>	<p>The device can be used as a wireless access point (AP mode) to facilitate users to configure the device, or it can also be used as a wireless information terminal (STA mode) to connect the remote server via wireless router.</p>																																																	

You may also add your domain name of WiFi card to easy access according below picture , after you set ok, input http://wifi, you may also access the related page.

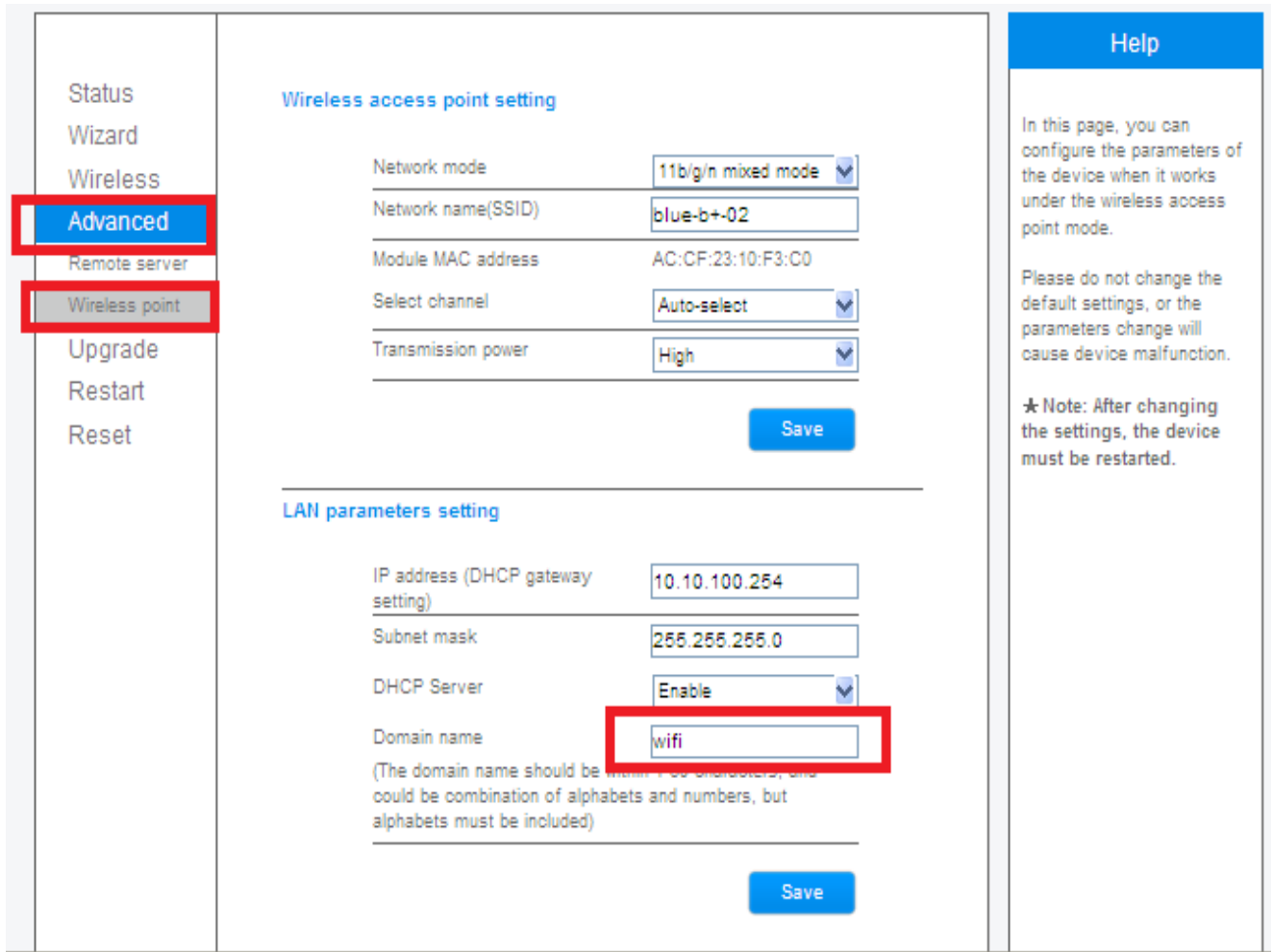

The screenshot shows a web-based configuration interface for a device. On the left is a vertical menu with options: Status, Wizard, Wireless, **Advanced** (highlighted with a red box), Remote server, **Wireless point** (highlighted with a red box), Upgrade, Restart, and Reset. The main content area is titled 'Wireless access point setting' and contains the following fields:

- Network mode: 11b/g/n mixed mode (dropdown)
- Network name(SSID): blue-b+-02
- Module MAC address: AC:CF:23:10:F3:C0
- Select channel: Auto-select (dropdown)
- Transmission power: High (dropdown)

Below this section is a 'Save' button. The next section is 'LAN parameters setting' with the following fields:

- IP address (DHCP gateway setting): 10.10.100.254
- Subnet mask: 255.255.255.0
- DHCP Server: Enable (dropdown)
- Domain name: **wifi** (highlighted with a red box)

Below this section is another 'Save' button. On the right side of the interface is a 'Help' section with text explaining the configuration options and a note: '★ Note: After changing the settings, the device must be restarted.'

Now we finish the network setting, please go to **8.3. Register on monitoring website.**

8.7 Ethernet card

Ethernet card is an optional device. If your inverter had installed the Ethernet card, please go to **8.3 Register on monitoring website.** If your inverter had not installed the Ethernet card, please go to **8.8. Installation of Ethernet card** first, then go to **8.3 Register on monitoring website.**

After unpacking the box, please check the parts according to the below list. Contact the manufacturer immediately when you find any damage, missing or wrong model.

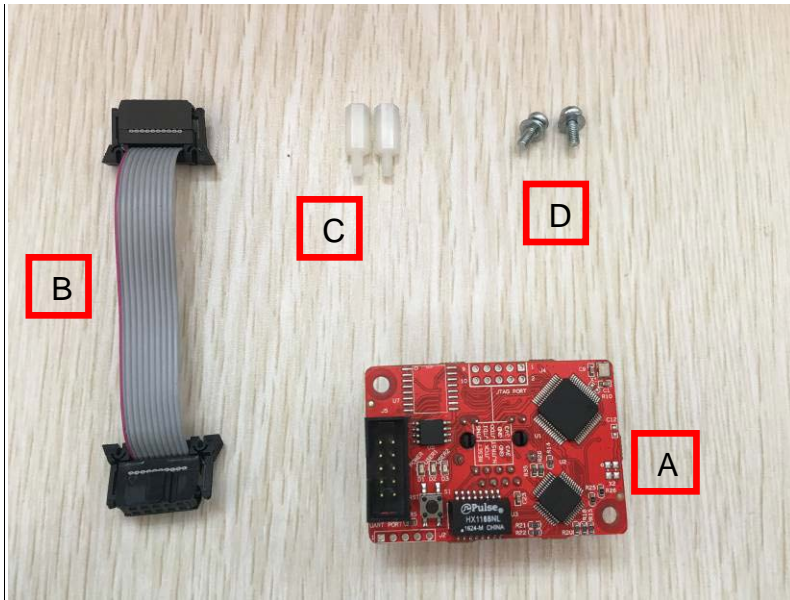

No.	Name	Quantity
A	PV data collector	1
B	Data line	1
C	Support pillar	2
D	Screw	2

Fig. Ethernet card

Ethernet card is shown as below:

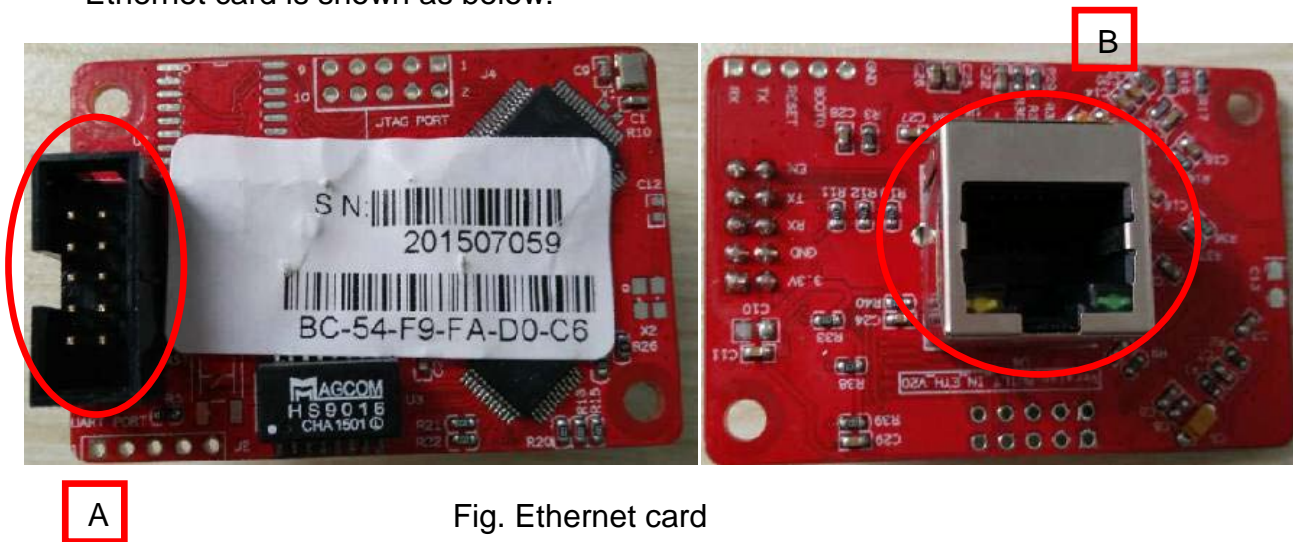

Fig. Ethernet card

No.	Name
A	10 pin connector
B	RJ45 connector



Fig. Serial number

8.8 Installation of Ethernet card

Warning: Before installing the Ethernet card to inverter, you must turn off both the AC side and DC side of inverter to make sure personal safety.



Fig. Dismantle the communication box

Unscrew the four screws on the interface panel with the screwdriver as shown in Picture above and keep the screws aside.



Fig. Install support pillar in the communication box

Install support pillar in the communication box as shown above.



Fig. Connect the cable to the Ethernet card

Pass the cable through the communication box and connect the network cable connector to the Ethernet card.

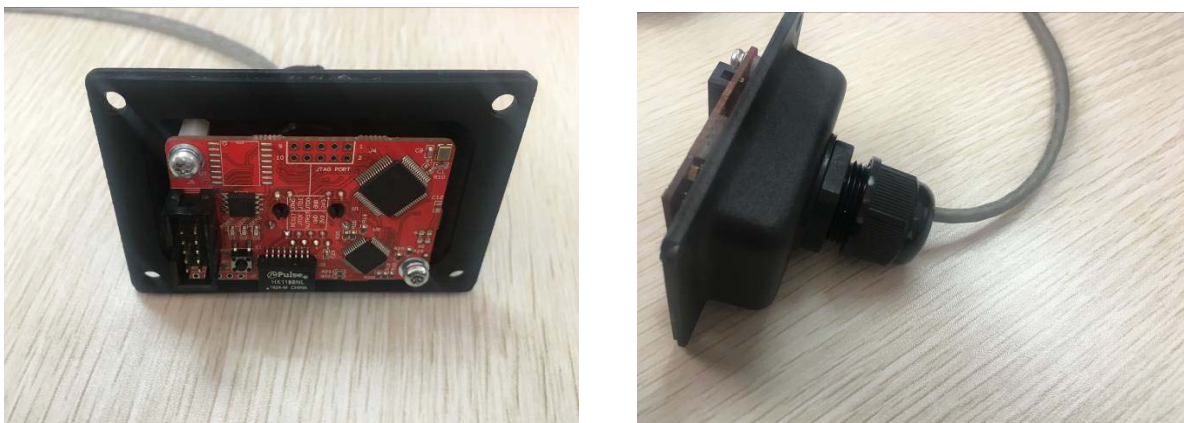

Fig. Fix the Ethernet card and tighten the connector

Fix the Ethernet card on the communication box and tighten the connector of the communication box. Then connect two sides of the data line to Ethernet card and inverter. Don't forget turn the switch up as shown below.



Fig. Connect the data line

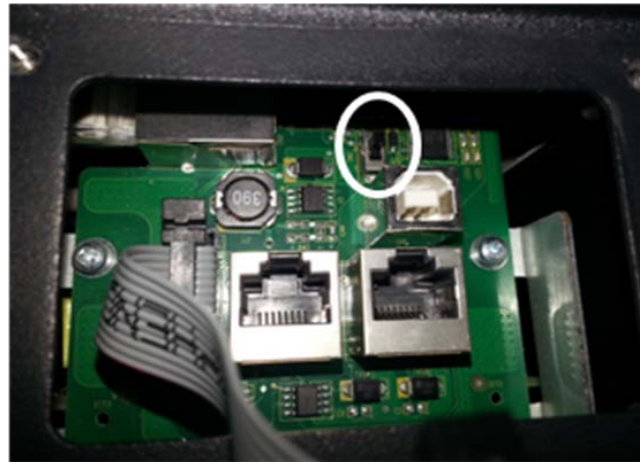



Fig. Turn the switch up

Install the communication box back to the inverter.

9. Recycling and Disposal

To comply with European Directive 2012/19/EU on waste Electrical and Electronic Equipment and its implementation as national law, electrical equipment that has reached the end of its life must be collected separately and returned to an approved recycling facility. Any device that you no longer required must be returned to your dealer or you must find an approved collection and recycling facility in your area.

Ignoring this EU Directive may have severe affects on the environment and your health.



WARNING



This device SHALL NOT be disposed of in residential waste.

10. Troubleshooting

Fault No.	Fault Info On Display	Possible Reasons	Solutions
F00	GFCI Device Fault	Inverter GFCI Detector Issue	1.Restart to check 2.Re-Flash software 3.Replace part or inverter
F01	Island Fault	No Grid or Local Grid Frequency Isn't Stable	Restart to check after local grid is stable Close the protection from the inverter
F03	PV Volt Low	DC voltage is below 150V	1.Correct the installation (Add Panels More) 2.Re-Flash software 3.Replace part or inverter
F04	Consistency Fault	The Data That Be Master And Slave CPU Detected Is Inconsistency	1.Restart to check 2.Re-Flash software 3.Replace part or inverter
F05	Bus Volt Low	1.Test Value Wrongly 2.Software Issue 3.Hardware Broken	1.Restart to check 2.Re-Flash software 3.Replace part or inverter
F06	Bus Volt High	1.Test Value Wrongly 2.Software Issue 3.Hardware Broken	1.Restart to check 2.Re-Flash software 3.Replace part or inverter
F09	No Utility	No AC voltage	Measure AC voltage with a multi meter Check the wires in AC cable
F10	Ground Current Fault	1.Poor grounding 2.It Often occurs in the rainy day.	.Make inverter grounded well 2.Change it to another standard with wider protection range under authorization
F11	Bus Unbalance	1.Inverter Control Circuit Problem 2.Values Of Two Rows Bus Capacitance Differ Too Much	1.Restart to check 2.Re-Flash software 3.Replace part or inverter
F12	10min Over Volt	Mean Value Within 10min Is Above 10% Of The Rated Grid Voltage	Change it to another standard with wider protection range under authorization
F13	Over Temp Fault	The temperature of internal device exceeds 80 °C	It happens rarely and can be used Normally

F15	PV Volt High	DC Voltage Is Too High Due To Wrong Installation	1. Correct The Installation (Remove Panels) 2. Re-Flash Software 3. Replace Part Or Inverter
F17	Grid Volt Fault	Grid Voltage Detection Within A Period Is Anomalous	Change the grid voltage protection range
F18	Isolation Fault	Impedance To Ground Between Battery Positive and Negative Is Less Than 2 MΩ	1. Remove this Fault 2. Change it to another standard with wider protection range under authorization
F19	Current DC Offset	A Phase Current Waveform That Be Detected Is Larger Deviation	Change it to another standard with wider protection range under authorization
F21	PV2 Over Current	The input current of PV2 is over rated value. May be there is something wrong with the hardware	1. Restart the inverter 2. If the problem persists, please replace the inverter.
F24	PV1 Over Current	The input current of PV1 is over rated value. May be there is something wrong with the hardware	1. Restart the inverter 2. If the problem persists, please replace the inverter.
F25	Relay Fault	General error in inverter start time, there may be damage of relay	If the problem persists, please replace the inverter.
F27	Inv Over Current	The inverter current is over rated value.	1. Restart the inverter to check 2. If it doesn't get back to normal please replace inverter
F29	Grid Freq Fault	The grid frequency exceeds the set range	Change it to another standard with wider protection range under authorization

11. Abbreviation

LCD	Liquid Crystal Display
LED	Light Emitting Diode
MPPT	Maximum Power Point Tracking
PV	Photovoltaic
V _{dc}	Voltage at the DC side
V _{ac}	Voltage at the AC side
V _{mpp}	Voltage at the Maximum Power Point
I _{mpp}	Amperage at Maximum Power Point
AC	Alternating Current (Form of electricity supplied by Utility Company)
DC	Direct Current (Form of electricity generated by PV modules)
DC Switch	Switch in the DC Circuit. Disconnects DC source from Inverter. May be integrated or external to Inverter

12. Contact

Omnik New Energy Co.,Ltd.(Headquarters)

Address: Third Floor,Building 3,No.63 Weixin Road,SIP,Suzhou,China

Tel: +86-512-6956-8216

Fax: +86-512-6295-6682

E-mail: sales@omnik-solar.com
sevice@omnik-solar.com

Website: www.omniksolar.com

Omnik German branch

Address: Omnik Gmbh Forsthausstr.8A 65479 Raunheim

Tel: +49(0) 1799762654

Mobile: +49(176) 30743149

E-mail: jingjing.zhang@omnik-solar.com

Omnik UK Service Partner

Address: 3 More London Riverside SE1 2RE,London

Tel: +86 512 69568216 8833

E-mail: Frank.Liu@omnik-solar.com

OmnikItaly Srl

Address: Via Francesco Baracca, 500043 Ciampino(Roma)

Tel: +39 06 211.26.522

Fax: +39 06 565.616.46

E-mail: info@omniksolar.it

Website: www.omniksolar.it

Omnik Netherlands Office

Address: Goudstraat 65,2718RD Zoetermeer, The Netherlands

Tel: +31 30265 7845

E-mail: [lena.wang@omnik-solar.com](mailto:lana.wang@omnik-solar.com)

GUARANTEE CARD

Agency retention

User information

Product Model	
Product ID	
Purchase Date	
Customer Name	

Historical Warranty

Warranty date	Troubleshooting	Finished date	Customer Signature

Client retention

User Information

Product Model	
Product ID	
Purchase Date	
Customer Name	

Historical Warranty

Warranty date	Troubleshooting	Finished date	Customer Signature

Warranty Terms

1. Please fill in this card carefully and read the following warranty terms carefully to ensure that the product is effectively guaranteed.
 - ① User keeps the card carefully when purchasing the product and asks the seller to seal it.
 - ② Provide the warranty card when repairing the machine in the warranty period.
 - ③ The information in this warranty card is true; otherwise it will not be valid.
 - ④ Warranty period is 5 years (standard) 10 years (selectable, effective after sealing) During the warranty period, if the product fails, the quality of the original device or the production problem, the company provides free maintenance and parts replacement.
2. The following reasons cannot be used normally in the warranty period.
 - ① Cause damage for not following the instructions.
 - ② All man-made or accidental product damage
 - ③ Without the company's approved repair, modification or product seal sticker damage.
 - ④ Aging bruising and scratches on the surface of the product.
3. After the warranty expires, the user can still get the maintenance services provided by the company, but the corresponding expenses shall be paid.