



- Growatt 2500MTL-S
- Growatt 3000MTL-S
- Growatt 3600MTL-S
- Growatt 4200MTL-S
- Growatt 5000MTL-S
- Growatt 5500MTL-S

## Installation & Operation Manual ►

Shenzhen Growatt New Energy Technology CO.,LTD  
Building B, Jiayu Industrial Park, #28, GuangHui Road,  
Shiyan Street, Baoan District, Shenzhen, P.R.China

T 0755-29515888  
F 0755-27472131  
E [service@ginverter.com](mailto:service@ginverter.com)  
W [www.ginverter.com](http://www.ginverter.com)

GR-UM-045-A-02

# list

## 1 Notes on this manual

- 1.1 Validity
- 1.2 Target Group
- 1.3 Additional information
- 1.4 Symbols in this document
- 1.5 Glossary

## 2 Safety

- 2.1 Intended Use
- 2.2 Qualification of skilled person
- 2.3 Safety instruction
- 2.4 Assembly Warnings
- 2.5 Electrical Connection Warnings
- 2.6 Operation Warnings

## 3 Product description

- 3.1 MTL-S Overview
- 3.2 Type label
- 3.3 Size and weight
- 3.4 Storage of Inverter
- 3.5 The advantage of the unit

## 4 Unpacking and inspection

## 5 Installation

- 5.1 Safety instructions
- 5.2 Selecting the installation location
- 5.3 Mounting the Inverter

## 6 Electrical connection

- 6.1 Safety
- 6.2 Wiring AC Output
- 6.3 connecting the second protective conductor
- 6.4 Connecting the PV Array (DC input)
- 6.5 Using shinetool to set the information of the inverter
- 6.6 Grounding the inverter
- 6.7 Selecting country by DIP switch
- 6.8 Inverter demand response modes (DRMs, only for Australia)

## 7 Commissioning

- 7.1 General LCD display
- 7.2 Operate by knock
- 7.3 Communications

## 8 Start-Up and shut down the inverter

- 8.1 Start-Up the inverter
- 8.2 Turn-off the Inverter

## 9 Maintenance and Cleaning

- 9.1 Checking Heat Dissipation
- 9.2 Cleaning the Inverter
- 9.3 Checking the DC Disconnect

## 10 Trouble shooting

- 10.1 Warnings(W)
- 10.2 Errors(E)

## 11 Manufacturer Warranty

## 12 Decommissioning

- 12.1 Dismantling the Inverter
- 12.2 Packing the Inverter
- 12.3 Storing the Inverter
- 12.4 Disposing of the Inverter

## 13 Technical Data

- 13.1 Specification
- 13.2 DC connector info
- 13.3 Torque
- 13.4 Accessories

## 14 PV system installation

## 15 Compliance Certificates

- 15.1 List
- 15.2 Download Address

## 16 Contact

# 1 Notes on this manual

## 1.1 Validity

This manual describes the assembly, installation, commissioning and maintenance of the following Growatt Inverter model:

Growatt 2500MTL-S  
Growatt 3000MTL-S  
Growatt 3600MTL-S  
Growatt 4200MTL-S  
Growatt 5000MTL-S  
Growatt 5500MTL-S

This manual does not cover any details concerning equipment connected to the Growatt MTL-S( e.g. PV modules). Information concerning the connected equipment is available from the manufacturer of the equipment.

## 1.2 Target Group

This manual is for qualified personnel. Qualified personnel have received training and have demonstrated skills and knowledge in the construction and operation of this device. Qualified Personnel are trained to deal with the dangers and hazards involved in installing electric devices.

## 1.3 Additional information





Find further information on special topics in the download area at [www.ginverter.com](http://www.ginverter.com)

The manual and other documents must be stored in a convenient place and be available at all times. We assume no liability for any damage caused by failure to observe these instructions. For possible changes in this manual, GROWATT NEW ENERGY TECHNOLOGY CO.,LTD accepts no responsibilities to inform the users.



## 1.4 Symbols in this document









### 1.4.1 Warnings in this document

A warning describes a hazard to equipment or personnel. It calls attention to a procedure or practice, which, if not correctly performed or adhered to, could result in damage to or destruction of part or all of the Growatt equipment and/or other equipment connected to the Growatt equipment or personal injury.

Symbol	description
 DANGER	DANGER indicates a hazardous situation which, if not avoided, will result in death or serious injury.
 WARNING	WARNING indicates a hazardous situation which, if not avoided, could result in death or serious injury.
 CAUTION	CAUTION indicates a hazardous situation which, if not avoided, could result in minor or moderate injury.
 NOTICE	NOTICE is used to address practices not related to personal injury.
 Information	Information that you must read and know to ensure optimal operation of the system.

### 1.4.2 Markings on this product

Symbol	Explanation
	Electrical voltage!
	Risk of fire or explosion !
	Risk of burns

	Operation after 5 minutes
	Point of connection for grounding protection
	Direct Current (DC)
	Alternating Current (AC)
	The inverter has no transformer.
	Read the manual
	Bluetooth communication is enabled.
	CE mark. The inverter complies with the requirements of the applicable EC guidelines.
	The inverter must not be disposed of with the household waste.

power of 2300 W for another half an hour, it has fed 3450Wh of energy into the power distribution grid within that hour.

#### Power

Power is measured in W (watts), kW (kilowatts) or MW (megawatts). Power is an instantaneous value. It displays the power your inverter is currently feeding into the power distribution grid.

#### Power rate

Power rate is the ratio of current power feeding into the power distribution grid and the maximum power of the inverter that can feed into the power distribution grid.

#### Power Factor

Power factor is the ratio of true power or watts to apparent power or volt amps. They are identical only when current and voltage are in phase than the power factor is 1.0. The power in an ac circuit is very seldom equal to the direct product of the volts and amperes. In order to find the power of a single phase ac circuit the product of volts and amperes must be multiplied by the power factor.

#### PV

Abbreviation for photovoltaic

#### wireless communication

The external wireless communication technology is a radio technology that allows the inverter and other communication products to communicate with each other. The external wireless communication does not require line of sight between the devices and it is selective purchasing.

## 1.5 Glossary

### AC

Abbreviation for "Alternating Current"

### DC

Abbreviation for "Direct Current"

### Energy

Energy is measured in Wh (watt hours), kWh (kilowatt hours) or MWh (megawatt hours). The energy is the power calculated over time. If, for example, your inverter operates at a constant power of 4600 W for half an hour and then at a constant

## 2 Safety

### 2.1 Intended Use

The unit converts the DC current generated by the photovoltaic (PV) modules to grid-compliant alternating current and performs single-phase feed-in into the electricity grid. Growatt 2500MTL-S, Growatt 3000MTL-S, Growatt 3600MTL-S, Growatt 4200MTL-S, Growatt 5000MTL-S, Growatt 5500MTL-S, inverters are built according to all required safety rules. Nevertheless, improper use may cause lethal hazards for the operator or third parties, or may result in damage to the units and other property.

Principle of a PV plant with this GROWATT XXXXMTL-S single-phase inverter

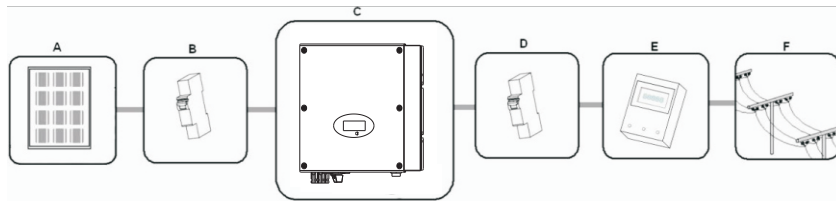

Position	Description
A	PV modules
B	DC load circuit breaker
C	Growatt Inverter
D	AC load circuit breaker
E	Energy meter
F	Utility grid

The inverter may only be operated with a permanent connection to the public power grid. The inverter is not intended for mobile use. Any other or additional use is not considered the intended use. The manufacturer/supplier is not liable for damage caused by such unintended use. Damage caused by such unintended use is at the sole risk of the operator.

### PV modules Capacitive Discharge Currents

PV modules with large capacities relative to earth, such as thin-film PV modules with cells on a metallic substrate, may only be used if their coupling capacity does not exceed 470nF. During feed-in operation, a leakage current flows from the cells to earth, the size of which depends on the manner in which the PV modules are installed (e.g. foil on metal roof) and on the weather (rain, snow). This "normal" leakage current may not exceed 50mA due to the fact that the inverter would otherwise automatically disconnect from the electricity grid as a protective measure.

### 2.2 Qualification of skilled person

This grid-tied inverter system operates only when properly connected to the AC - distribution network. Before connecting the Growatt MTL-S to the power distribution grid, contact the local power distribution grid company. This connection must be made only by qualified technical personnel to connect, and only after receiving appropriate approvals, as required by the local authority having jurisdiction.

### 2.3 Safety instruction

The GROWATT MTL-S Inverters is designed and tested according to international safety requirements (IEC62109-1, VDE-AR-N4105, CE, VDE0126-1-1, CE10-21 AS4777, NBT32004-2013, EN50438); however, certain safety precautions must be observed when installing and operating this inverter. Read and follow all instructions, cautions and warnings in this installation manual. If questions arise, please contact Growatt's technical services at +86 (0)755 2747 1900.



### 2.4 Assembly Warnings

	<ul style="list-style-type: none"> <li>➤ Prior to installation, inspect the unit to ensure absence of any transport or handling damage, which could affect insulation integrity or safety clearances; failure to do so could result in safety hazards.</li> <li>➤ Assemble the inverter per the instructions in this manual. Use care when choosing installation location and adhere to specified cooling requirements.</li> <li>➤ Unauthorized removal of necessary protections, improper use, incorrect installation and operation may lead to serious safety and shock hazards and/or equipment damage.</li> <li>➤ In order to minimize the potential of a shock hazard due to hazardous voltages, cover the entire solar array with dark material prior to connecting the array to any equipment.</li> </ul>
---	--



 <b>CAUTION</b>	<ul style="list-style-type: none"> <li>➤ Grounding the PV modules : The Growatt MTL-S is a transformerless inverter. That is why it has no galvanic separation. Do not ground the DC circuits of the PV modules connected to the Growatt MTL-S. Only ground the mounting frame of the PV modules. If you connect grounded PV modules to the Growatt MTL-S, the error message "PV ISO Low".</li> <li>➤ Comply with the local requirements for grounding the PV modules and the PV generator. GROWATT recommends connecting the generator frame and other electrically conductive surfaces in a manner which ensures continuous conduction with ground in order to have optimal protection of the system and personnel.</li> </ul>
---	--

 <b>CAUTION</b>	<ul style="list-style-type: none"> <li>➤ The Growatt Inverter converts DC Current from PV generator into AC current. The inverter is suitable for mounting indoors and outdoors.</li> <li>➤ You can use the AC current generated as follows:</li> </ul>
House grid:	Energy flows into the house grid. The consumers connected, for example, household devices or lighting, consume the energy. The energy left over is fed into the public grid. When the Growatt is not generating any energy, e.g., at night, the consumers which are connected are supplied by the public grid. The Growatt does not have its own energy meter. When energy is fed into the public grid, the energy meter spins backwards
Public grid:	Energy is fed directly into the public grid. The Growatt is connected to a separate energy meter. The energy produced is compensated at a rate depending on the electric power company.

## 2.5 Electrical Connection Warnings

 <b>DANGER</b>	<ul style="list-style-type: none"> <li>➤ The components in the inverter are live. Touching live components can result in serious injury or death. <ul style="list-style-type: none"> <li>◆ Do not open the inverter except the wire box by qualified persons.</li> <li>◆ Electrical installation, repairs and conversions may only be carried out by electrically qualified persons.</li> <li>◆ Do not touch damaged inverters.</li> </ul> </li> <li>➤ Danger to life due to high voltages in the inverter <ul style="list-style-type: none"> <li>◆ There is residual voltage in the inverter. The inverter takes 20 minutes to discharge</li> <li>◆ Wait 20 minutes before you open the wire box.</li> </ul> </li> <li>➤ Persons with limited physical or mental abilities may only work with the Growatt inverter following proper instruction and under constant supervision. Children are forbidden to play with the Growatt inverter. Must keep the Growatt inverter away from children.</li> </ul>
 <b>WARNING</b>	<ul style="list-style-type: none"> <li>➤ Make all electrical connections (e.g. conductor termination, fuses, PE connection, etc.) in accordance with prevailing regulations. When working with the inverter powered on, adhere to all prevailing safety regulations to minimize risk of accidents.</li> <li>➤ Systems with inverters typically require additional control (e.g., switches, disconnects) or protective devices (e.g., fusing circuit breakers) depending upon the prevailing safety rules.</li> </ul>

## 2.6 Operation Warnings

 <b>WARNING</b>	<ul style="list-style-type: none"> <li>➤ Ensure all covers and doors are closed and secure during operation.</li> <li>➤ Although designed to meet all safety requirements, some parts and surfaces of Inverter are still hot during operation. To reduce the risk of injury, do not touch the heat sink at the back of the PV-Inverter or nearby surfaces while Inverter is operating.</li> <li>➤ Incorrect sizing of the PV plant may result in voltages being present which could destroy the inverter. The inverter display will read the error message "PV-Voltage High!" <ul style="list-style-type: none"> <li>◆ Turn the rotary switch of the DC Disconnect to the Off position immediately.</li> <li>◆ Contact installer.</li> </ul> </li> </ul>
 <b>CAUTION</b>	<ul style="list-style-type: none"> <li>➤ All operations regarding transport, installation and start-up, including maintenance must be operated by qualified, trained personnel and in compliance with all prevailing codes and regulations.</li> <li>➤ Anytime the inverter has been disconnected from the power network, use extreme caution as some components can retain charge sufficient to create a shock hazard; to minimize occurrence of such conditions, comply with all corresponding safety symbols and markings present on the unit and in this manual.</li> <li>➤ In special cases, there may still be interference for the specified application area despite maintaining standardized emission limit values (e.g. when sensitive equipment is located at the setup location or when the setup location is near radio or television receivers). In this case, the operator is obliged to take proper action to rectify the situation.</li> <li>➤ Do not stay closer than 20 cm to the inverter for any length of time.</li> </ul>

# 3 Product description

## 3.1 MTL-S Overview

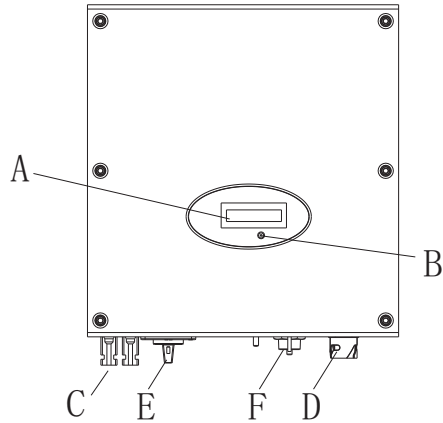

Position	Description
A	LCD
B	LED
C	PV input
D	AC Output
E	DC Switch
F	Rj45 Port

 <b>Information</b>	The DC switch of Growatt MTL-S series is optional for different countries.
---	--

### Symbol on the inverter

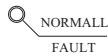
Position	Description	Explanation
	Tap symbol	Setting the display operation by tapping the LCD (see Section 7).
	Inverter status symbol	Indicates inverter operation status

## 3.2 Type label

The type labels provide a unique identification of the inverter (The type of product, Device-specific characteristics, Certificates and approvals). The type labels are on the right-hand side of the enclosure.

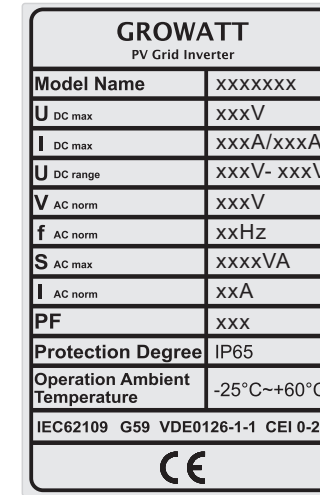

More details about the type label as the chart below:

Model Name	Growatt 2500MTL-S	Growatt 3000MTL-S	Growatt 3600MTL-S
Max input DC voltage	500V	500V	550V
Max input DC current	10A/10A	10A/10A	10A/10A
PV voltage range	70V~500V	70V~500V	70V~550V
AC nominal voltage	230V	230V	230V
AC grid frequency	50HZ	50HZ	50HZ
Max. apparent power	2500VA	3000VA	3600VA
AC normal output current	10.8A	13A	15.6A
Power factor	0.8leading-0.95laging	0.8leading-0.95laging	0.8leading-0.95laging
Environmental Protection Rating	IP 65		
Operation Ambient temperature	-25...+60°C (-13...+ 140°F) with derating above 45°C (113°F)		



Model Name	Growatt 4200MTL-S	Growatt 5000MTL-S	Growatt 5500MTL-S
Max input DC voltage	550V	550V	550V
Max input DC current	15A/15A	15A/15A	15A/15A
PV voltage range	70V~550V	70V~550V	70V~550V
AC nominal voltage	230V	230V	230V
AC grid frequency	50Hz/60Hz	50Hz/60Hz	50Hz/60Hz
Max. apparent power	4200VA	4600VA	5000VA
AC normal output current	18.5A	20A	21.8A
Power factor	0.8leading-0.95laging	0.8leading-0.95laging	0.8leading-0.95laging
Environmental Protection Rating	IP 65		
Operation Ambient temperature	-25...+60°C (-13...+ 140°F) with derating above 45°C (113°F)		

### 3.3 Size and weight

#### Dimensions and weight

Model	Height (H)	Width (W)	Depth (D)	Weight
Growatt 2500 MTL-S	419mm 16.5inch	355mm 14inch	138mm 5.4inch	14kg
Growatt 3000 MTL-S	419mm 16.5inch	355mm 14inch	138mm 5.4inch	14kg
Growatt 3600 MTL-S	419mm 16.5inch	355mm 14inch	138mm 5.4inch	14kg
Growatt 4200 MTL-S	419mm 16.5inch	355mm 14inch	138mm 5.4inch	14kg
Growatt 5000 MTL-S	419mm 16.5inch	355mm 14inch	158mm 6.2inch	14.5kg
Growatt 5500 MTL-S	419mm 16.5inch	355mm 14inch	158mm 6.2inch	14.5kg

### 3.4 Storage of Inverter

If you want to storage the inverter in your warehouse, you should choose an appropriate location to store the inverter.

- > The unit must be stored in original package and desiccant must be left in the package.
- > The storage temperature should be always between -25°C and +60°C. And the storage relative humidity can achieve to 100%.
- > If there are a batch of inverters need to be stored, the maximum layers for original carton is four.
- > After long term storage, local installer or service department of GROWATT should perform a comprehensive test before installation

 <b>Information</b>	<p>After long term storage, the Real Time Clock of the inverter maybe not correct ,it will cause the energy produced today (E_today)error ,you need to set the time and date, refer to clause 7. 2.5 setting date and time .</p>
---	--

### 3.5 The advantage of the unit

- > Maximum efficiency of 97.5%
- > Wide input voltage range from 70--550Vdc
- > Reactive power regulate
- > Integrated DC switch
- > Multi MPP controller
- > DSP controller
- > Sound control
- > Multi communication pattern
- > Easy installation

## 4 Unpacking and inspection

The inverter is thoroughly tested and inspected strictly before delivery. Our inverters leave our factory in proper electrical and mechanical condition. Special packaging ensures safe and careful transportation. However, transport damage may still occur. The shipping company is responsible in such cases. Thoroughly inspect the inverter upon delivery. Immediately notify the responsible shipping company if you discover any damage to the packaging which indicates that the inverter may have been damaged or if you discover any visible damage to the inverter. We will be glad to assist you, if required. When transporting the inverter, the original or equivalent packaging should be used, and the maximum layers for original carton is four, as this ensures safe transport.

After opening the package, please check the contents of the box. It should contain the following. Please check all of the accessories carefully in the carton. If anything missing, contact your dealer at once.

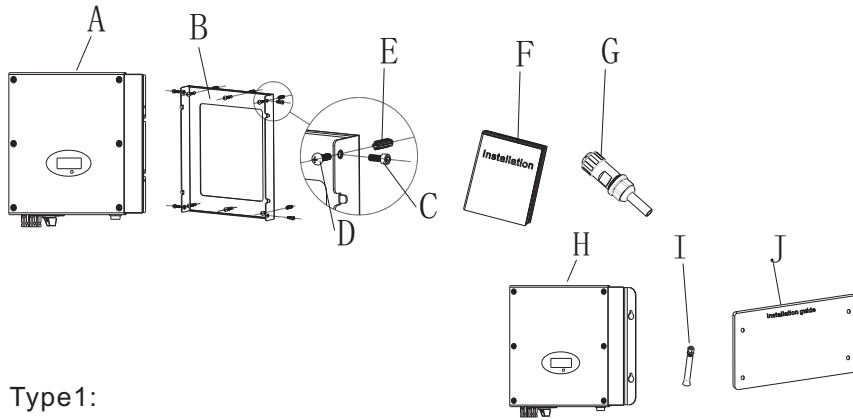

### Type1:



Item	Name	Number
A	Inverter	1
B	Mounting frame	1
C	Safety-lock screws	4
D	Mounting screws	6
E	Mounting frame screws sleeve	6
F	User manual	1
G	Cable gland for AC connection	1

### Type2:

Item	Name	Number
H	Inverter	1
J	Paper board	1
I	Explosion bolts	4
F	User manual	1
G	Cable gland for AC connection	1

## Installation 5

### 5.1 Safety instructions

	<p>Danger to life due to fire or explosion</p> <ul style="list-style-type: none"> <li>➤ Despite careful construction, electrical devices can cause fires.</li> <li>➤ Do not install the inverter on easily flammable materials and where flammable materials are stored.</li> </ul>
	<p>Risk of burns due to hot enclosure parts</p> <p>Mount the inverter in such a way that it cannot be touched inadvertently.</p>

### 5.2 Selecting the installation location

- This is guidance for installer to choose a suitable installation location, to avoid potential damages to device and operators.
- The installation location must be suitable for the inverter's weight and dimensions for a long period time.
- Select the installation location so that the status display can be easily viewed.
- Do not install the inverter on structures constructed of flammable or thermolabile materials.
- Never install the inverter in environment of little or no air flow, nor dust environment. That may derate the efficiency of the cooling fan of the inverter.
- The Ingress Protection rate is IP65 which means the inverter can be installed outdoors and indoors.
- The humidity of the installation location should be 100% without condensation.
- The installation location must be freely and safely to get at all times.
- Vertically installation and make sure the connection of inverter must be downwards. Never install horizontal and avoids forward and sideways tilt.

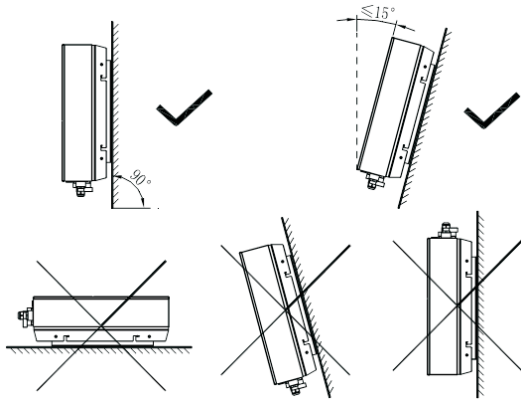

- Be sure that the inverter is out of the children's reach.
- Don't put any things on the inverter. Do not cover the inverter.
- Do not install the inverter near television antenna or any other antennas and antenna cables.
- Inverter requires adequate cooling space. Providing better ventilation for the inverter to ensure the heat escape adequately. The ambient temperature should be below 40°C to ensure optimum operation.
- Do not expose the inverter to direct sunlight, as this can cause excessive heating and thus power reduction.
- Observe the Min. clearances to walls, other inverters, or objects as shown in the diagram:

Direction	Min. clearance (cm)
above	30
below	50
sides	30
front	30

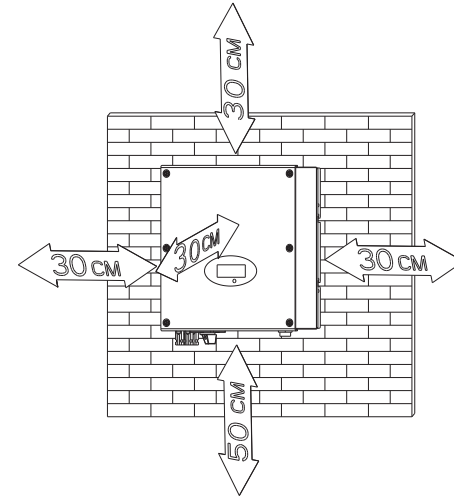

Ambient dimensions of one inverter

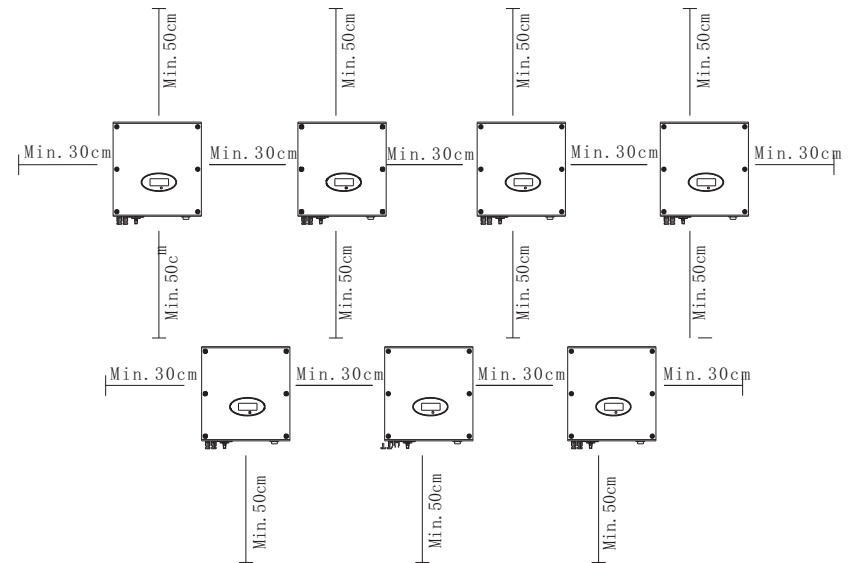

Ambient dimensions of a series inverters

- There must be sufficient clearance between the individual inverters to ensure that the cooling air of the adjacent inverter is not taken in.
- If necessary, increase the clearance spaces and make sure there is enough fresh air supply to ensure sufficient cooling of the inverters.
- The inverter can't install to solarization, drench, firm location. We suggest that the inverters should be installed at the location with some cover or protection..



- Please make sure the inverter is installed at the right place. The inverter can't install close to trunk.

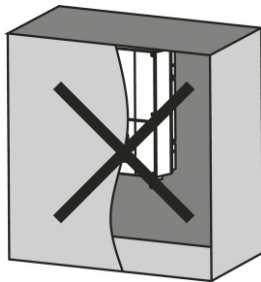

## 5.3 Mounting the Inverter

### 5.3.1 Mounting the Inverter with bracket

 <b>DANGER</b>	<p>In order to avoid electrical shock or other injury, inspect existing electronic or plumbing installations before drilling holes.</p>
-------------------	---

 <b>NOTICE</b>	<p>There are two types of installation mode, please choose the corresponding installation instructions.</p>
-------------------	---

#### Type1:

- Using the mounting frame as a template, drill 4 holes as illustrated in image.

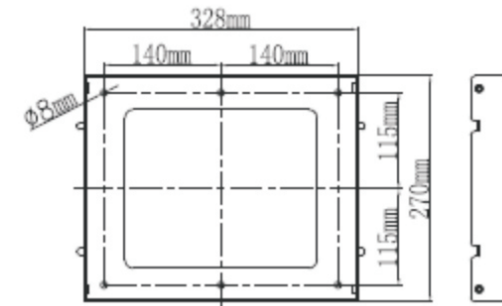

- Fix the mounting frame as the figure shows. Do not make the screws to be flush to the wall. Instead, leave 2 to 4mm exposed.

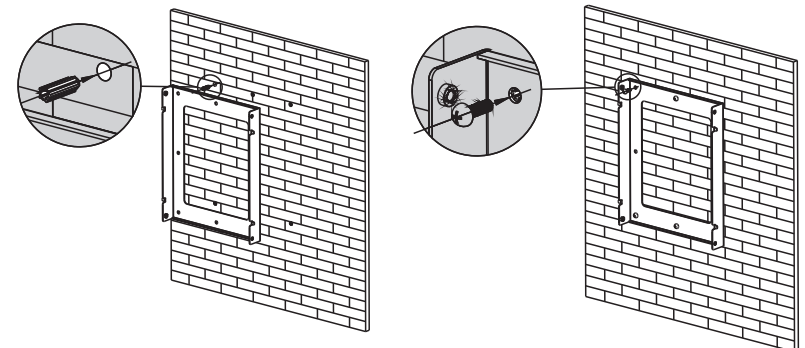

### Type2:

- Mark four points at the wall via the hole of the paper board ,then remove the paper board or mounting frame .

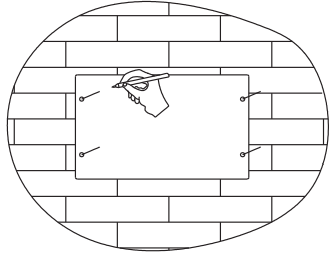

- Knock explosion bolt into the  $\varnothing 8$  holes, screw the nuts to fix the bolt.

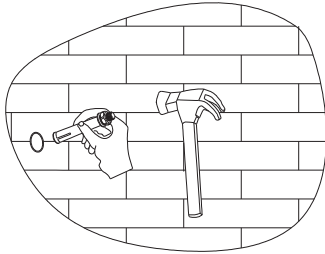

### 5.3.2 Fixed the inverter on the wall



Falling equipment can cause serious or even fatal injury, never mount the inverter on the bracket unless you are sure that the mounting frame is really firmly mounted on the wall after carefully checking.

#### Type1:

- Rise up the inverter a little higher than the bracket. Considered the weight of them. During the process please maintain the balance of the inverter.

Hang the inverter on the bracket through the match hooks on bracket.

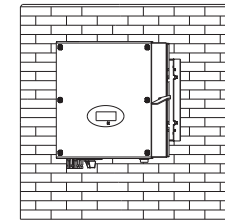

- After confirming the inverter is fixed reliably, fasten four M6 safety-lock sockets head cap screws on the left and right side firmly to prevent the inverter from being lifted off the bracket.

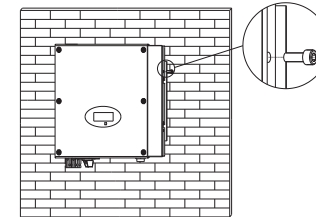

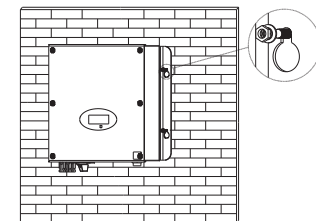

#### Type2:

- Hang MTL-S onto the explosion bolt, then screw the four nuts with spanner to fix MTL-S tightly.





# 6 Electrical Connection

## 6.1 Safety

	<p>Danger to life due to lethal voltages! High voltages which may cause electric shocks are present in the conductive parts of the inverter. Prior to performing any work on the inverter, disconnect the inverter on the AC and DC sides</p>
 <b>WARNING</b>	<p>Danger of damage to electronic components due to electrostatic discharge. Take appropriate ESD precautions when replacing and installing the inverter.</p>

## 6.2 Wiring AC Output

 <b>WARNING</b>	<ul style="list-style-type: none"> <li>You must install a separate single-phase circuit-breaker or other load disconnection unit for each inverter in order to ensure that the inverter can be safely disconnected under load.</li> <li><b>NOTE:</b>The inverter is equipped with integrated RCM(Residual current operated monitor)and RCD(Residual current and protective device) which are used for preventing from being electric shock. An external built RCD in fact is not necessary . If the network operator stipulate an external built RCD,you must choose a residual-current protective device that triggers in the event of residual current more than 300mA.</li> </ul>
 <b>NOTICE</b>	<ul style="list-style-type: none"> <li>When using inverter with VDE-AR-N 4105, because the inverter's displacement factor adjust function had to accorded to VDE-AR-N 4105,the PV-inverter system total capacity cannot be over 13.8KVA.</li> <li>When using inverter with CEI 0-21: if the inverter system total capacity more than 3KW and up to 6KW,the displacement factor is adjustable between 0.95leading to 0.95 lagging ,and not need the external SPI.if the inverter system total capacity more than 6KW,,the displacement factor is adjustable between 0.9leading to 0.9 lagging ,and need the external SPI.</li> </ul>

You must install a separate single-phase circuit-breaker or other load disconnection unit for each inverter in order to ensure that the inverter can be safely disconnected under load.

We suggest you choice the AC breaker rating current in this table:

Growatt 2500MTL-S	18A/230V
Growatt 3000MTL-S	20A/230V
Growatt 3600MTL-S	24A/230V
Growatt 4200MTL-S	28A/230V
Growatt 5000MTL-S	30A/230V
Growatt 5500MTL-S	32A/230V

we recommend electrical connection as follows

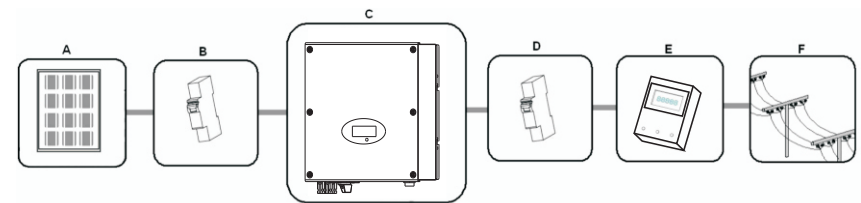

Position	Description
A	PV modules
B	DC load circuit breaker
C	Growatt Inverter
D	AC load circuit breaker
E	Energy meter
F	Utility grid

The AC wiring step:

1. The grid connection is made using 3 conductors (L, N, and PE).

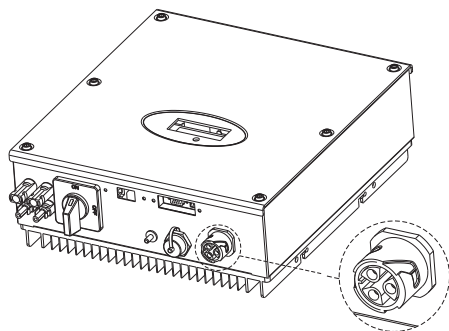

2. Remove the parts of the AC connection plug from the accessory bag. Guide the pressure screw, sealing ring, threaded sleeve over the AC cable.

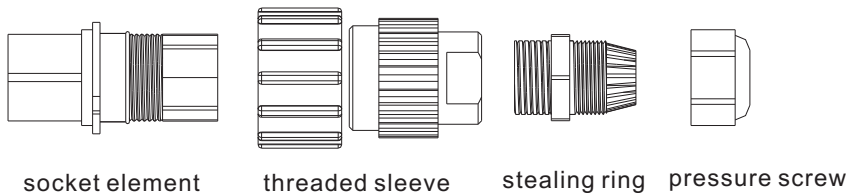

3. Insert the stripped and bared conductors L,N,PE into the screw terminals with sign L,N,PE on the socket element and tighten the screws firmly.

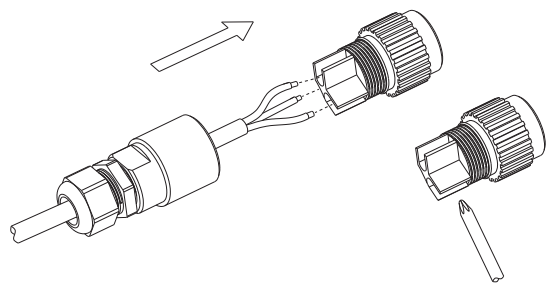

4. Push the threaded sleeve into the socket element; screw the pressure screw tightly onto the threaded sleeve;

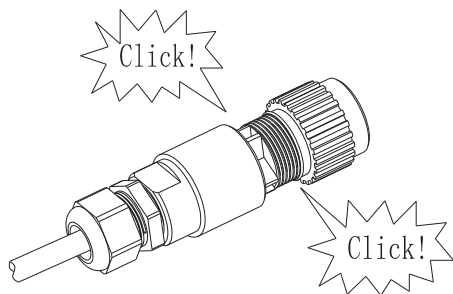

5. Finally, insert the AC connection plug into the AC connection receptacle on the inverter.

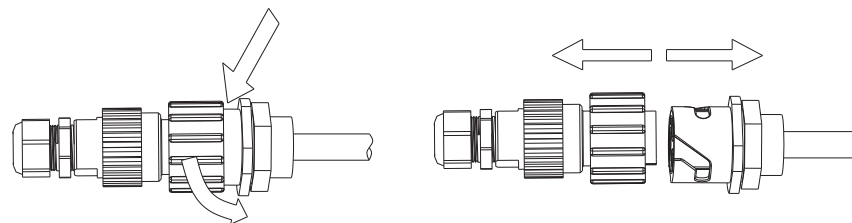

Lock the housing

Unlock the housing

Wire suggestion length:

Conductor cross section	Max. cable length		
	Growatt 2500MTL-S	Growatt 3000MTL-S	Growatt 3600MTL-S
5.2 mm <sup>2</sup> 10AWG	48m	40m	33m
6.6 mm <sup>2</sup> 9AWG	60m	50m	42m

Conductor cross section	Max. cable length		
	Growatt 4200MTL-S	Growatt 5000MTL-S	Growatt 5500MTL-S
5.2 mm <sup>2</sup> 10AWG	28m	26m	24m
6.6 mm <sup>2</sup> 9AWG	36m	33m	30m

### 6.3 connecting the second protective conductor

If the installation requires, the ground terminal can be used to connect a second protective conductor or as a equipotential bonding. the second protective poing local as figure below.

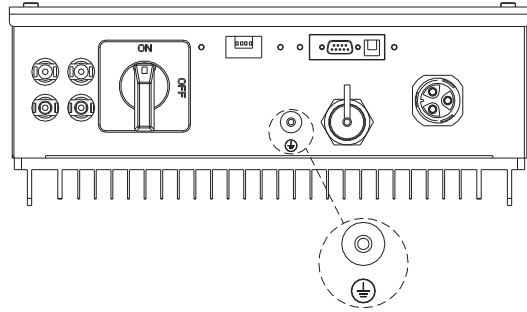

## 6.4 Connecting the PV Array (DC input)

### 6.4.1 Conditions for DC Connection

The Growatt MTL-S single-phase inverter has 2 independent input : input A & input B.

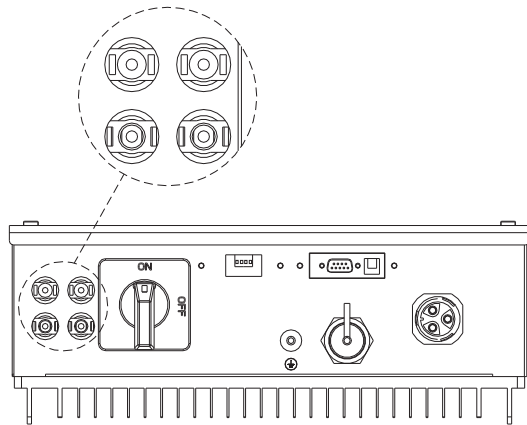

The diagram drawing of DC side is shown as below, notice that the connectors are in paired (male and female connectors). The connectors for PV arrays and inverters are H4 connectors;

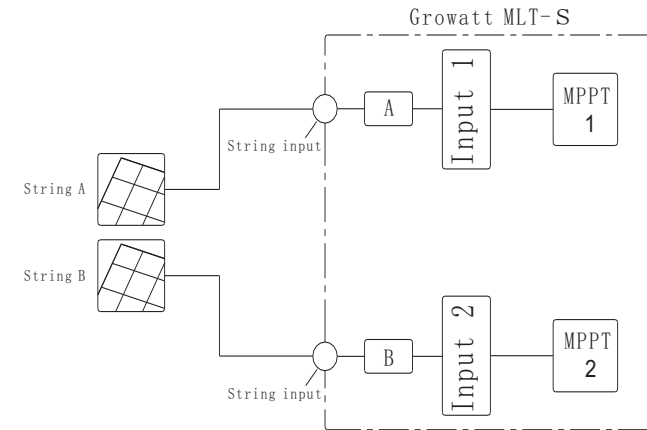



Suggestions for the PV modules of the connected strings:

- Same type
- Same quantity of PV modules connected in series

 <b>CAUTION</b>	<p>If the inverter is not equipped with a DC switch but this is mandatory in the country of installation, install an external DC switch.</p> <p>The following limit values at the DC input of the inverter must not be exceeded:</p>		
	Types	Max current input A	Max current input B
	Growatt 2500MTL-S	10A	10A
	Growatt 3000MTL-S	10A	10A
	Growatt 3600MTL-S	10A	10A
	Growatt 4200MTL-S	15A	15A
	Growatt 5000MTL-S	15A	15A
	Growatt 5500MTL-S	15A	15A



### 6.4.2 Connecting the PV Array (DC input)

 <p><b>DANGER</b></p>	<p><b>Danger to life due to lethal voltages!</b></p> <p>Before connecting the PV array, ensure that the DC switch and AC breaker are disconnect from the inverter. NEVER connect or disconnect the DC connectors under load. Make sure the maximum open circuit voltage (Voc) of each PV string is less than 550Vdc. Check the design of the PV plant. The Max. open circuit voltage, which can occur at solar panels temperature of -10°C, must not exceed the Max. input voltage of the inverter.</p>
 <p><b>WARNING</b></p>	<p>Improper operation during the wiring process can cause fatal injury to operator or unrecoverable damage to the inverter. Only qualified personnel can perform the wiring work.</p>

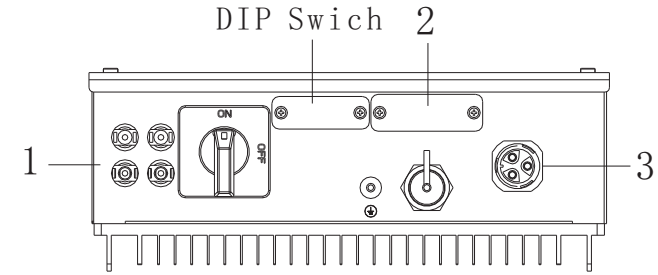

1. DC Connector 2. RS232 Interface 3. AC Connector

NOTE: Before selecting country, please turn off DC input and AC grid, then unscrew the dam-board of the DIP switch by appropriate tool.

### 6.5 Using shinetool to set the information of the inverter

About the software of shinetool and the usage of it please download from the web: [www.ginverter.com/Download.aspx](http://www.ginverter.com/Download.aspx)

### 6.6 Grounding the inverter

The inverter must be connected to the AC grounding conductor of the power distribution grid via the ground terminal (PE) 

 <p><b>WARNING</b></p>	<p>Because of the transformerless design, the DC positive pole and DC negative pole of PV arrays are not permitted to be grounded.</p>
---	--

### 6.7 Selecting country by DIP switch



#### 6.7.1 Location of the DIP switch

The DIP switch is located on the left of the RS232 interface at the bottom of the inverter, as the figure below.

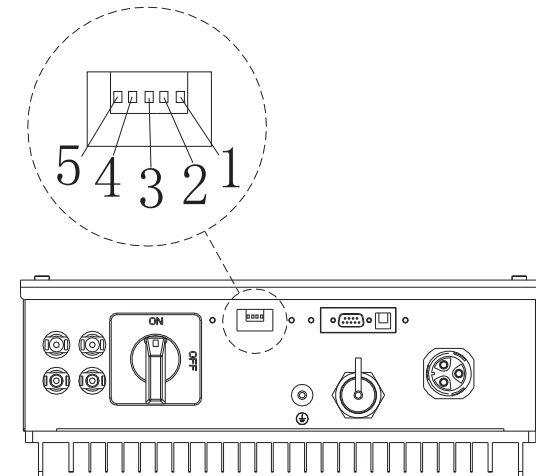
The internal structure of the DIP switch is as the following figure:



## 6.7.2 DIP switch option corresponding to the country

 <b>DANGER</b>	When setting the DIP, you must turn off the AC breaker and DC breaker.
 <b>NOTICE</b>	<ul style="list-style-type: none"> <li>● After setting the DIP, please power on the inverter and check the model display. If the last character of the model name is corresponding to the country safety standard as the above table, it means your setting is successful.</li> <li>● You should change the time displayed on the LCD of inverter to your local time after inverter starts up.</li> </ul> <p>If the country is set incorrectly, please shut down the inverter and set again.</p>

When the cables of AC side and DC side are all well connected, before commissioning, the country safety standard must be selected by the DIP switch.

The DIP switch is composed of five-digit binary number PINS. The different combination of the five PINS can represent different inverter's model, which is corresponding to the local grid standard. Each small white PIN has two statuses, when set upward to 'ON', its value turns to '1', when set downward, its value turns to '0'. Concerning the matching of the PIN status and the country safety standard, please refer to the attached table.

## 6.8 Inverter demand response modes (DRMs, only for Australia)

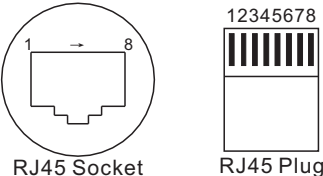

This series inverter has the function of demand response modes, moreover, We use RJ45 socket as inverter DRED connection.

### 6.8.1 RJ45 socket pin assignment

PIN	Assignment for inverterscapable of both charging and discharging	Pin Assignments Front View
1	DRM5	 <p>RJ45 Socket      RJ45 Plug</p>
2	DRM6	
3	DRM7	
4	DRM8	
5	RefGen	
6	COM/DRM0	
7	/	
8	/	

### 6.8.2 Method of asserting demand response modes

MODE	Rj45 socket Asserted by shorting pins		Requirement
DRM0	5	6	Operate the disconnection device
DRM5	1	5	Do not generate power
DRM6	2	5	Do not generate at more than 50% of rated power
DRM7	3	5	Do not generate at more than 75% of rated power AND Sink reactive power if capable
DRM8	4	5	Increase power generation (subject to constraints from other active DRMs)

 <b>DANGER</b>	Do not disconnect the DC connectors under load.
 <b>WARNING</b>	Improper operation during the wiring process can cause fatal injury to operator or unrecoverable damage to the inverter. Only qualified personnel can perform the wiring work.

Requirements :

- ✓ The AC cable is correctly connected.
- ✓ The DC cable is correctly connected.
- ✓ The country is set incorrectly(See accessory.)

## 7.1 General LCD display

### 7.1.1 Power on display

When inverter powered on, LCD background will light automatically. Starting-up display sequence, once the PV power is sufficient, inverter displays information as shown in the flow chart as follow:

Module: xxxxxx  
 SerNo: xxxxxxxxxx  
 FW Version: x.x.x  
 Connect in: xxS  
 Connect: OK  
 xxxx.xVA xxxx.x W

### 7.1.2 LCD Display when background light off

After power on information displayed, there will be another 4 interfaces displayed in turn, if there is no knock signal input.

## The First Line Of LCD

STATE	DISPLAY CONTENT	REMARK
Wait State	Standby	PV voltage low
	Waiting	Initial waiting
	Connect in xxS	System checking
	Reconnect in xxS	System checking
Inverter State	Connect OK	Connect to Grid
	xxxx.xVA xxx.x W	Inverter watt at working
Fault State	Error: xxx	System Fault
Auto Test State	Auto Testing	Protection auto test
Program State	Programming	Update Software

Position	Detail
A	Inverter operation message
B	Inverter state information

### 7.1.3 The Second line can change by knock on

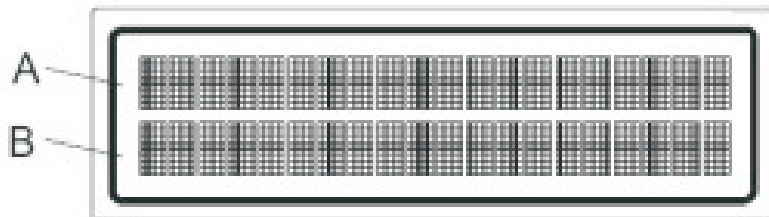

CYCLE DISPLAY	DISPLAY TIME/S	REMARK
4520.9VA 4515.3W Model: GTAS007151	2	The inverter model
4520.9VA 4515.3W FW Version: AS 1.0	2	The software version
4520.9VA 4515.3W SerNO: XXXXXX	2	The Serial Number
4520.9VA 4515.3W Etoday: 8.5KWh	4	The energy today

CYCLE DISPLAY	DISPLAY TIME/S	REMARK
4520.9VA 4515.3W Ea11: 08KWH	4	The energy all
4520.9VA 4515.3W Ppv: 2427 / 2447W	4	PV input watt
4520.9VA 4515.3W PV: 290/292 B: 359	4	The PV and Bus Votage
4520.9VA 4515.3W AC: 230V F: 50.1HZ	4	The grid system
4520.9VA 4515.3W Enable Auto Test	4	Enable auto test
4520.9VA 4515.3W COM Address: 06	4	Communications Address of the inverter
4520.9VA 4515.3W Zigbee no conn	4	Set Zigbee Channal
4520.9VA 4515.3W AC Error Record	4	The last 5dated failure reports
4520.9VA 4515.3W 2012/05/05 09:06	4	year/month/day/time of the inverter
4520.9VA 4515.3W Setting...	4	Setting status

#### 7.1.4 Connecting messages

When inverter started to connect to grid, the following message will appear on LCD screen.

4520.9VA 4515.3W  
Etoday: xx.xkWh

Connect to gird interface

## 7.2 Operate by knock

### 7.2.1 Knock type and definition

The inverter can support three kinds of knock: single knock, double knock and thrice knock. Each kind of knock has different function. Refer to specified definition in Table below:

Knock type	Definition
Single knock	KeyDown
Double knock	KeySET
Thrice knock	KeyEnter&ESC

### 7.2.2 Light background and check running information

Before light the background, the three types of knock functions are the same: just light the background.

Note: That the background light will automatically off if there is no knock detected in 180seconds.

### 7.2.3 Set inverter's COM address

When communicating with monitoring software or device, the software or device may regard inverter's COM address as communication address (Also may use inverter's serial number as communication address).

Before entering the 'COM Address: xxx' setting interface, you need to enter a password as below:

4505.5VA 4485.5W  
Setting...

4505.5VA 4485.5W  
INPUT 123:XXX

According to the LCD display, you need to input three numbers: 123. You should finish several steps as below:

1. When the LCD stays bright, single knock to 'Setting...', and then double knock to enter 'INPUT 123:xxx' interface.
2. Double knock to make the first number flash, single knock to change the number, and the first number you need to input is '1'. Double knock to enter the second number while the first number was '1'.
3. When the second number is flashing, single knock to change the number, and the second number you need to input is '2'. Double knock to enter the last number while the first number was '2'.
4. When LCD displays 'INPUT 123:123', triple knock to enter the setting interface.
5. Single knock to 'COM Address: xxx', and then double knock to enter the setting status, single knock to change the COM Address. When setting finishes, wait for 30s or triple knock to save your setting.

4505.5VA 4485.5W  
COM Address: 01

### 7.2.4 Set inverter display language

1. If you want to set inverter display language, repeat the steps as described in section 7.2.3.
2. When LCD displays 'INPUT 123:123', triple knock to enter the setting interface.
3. Single knock to select the language you want, when setting finishes, wait for 30s or triple knock to save your setting.

4505.5VA 4485.5W  
Set Language

The inverter provides seven languages: English, German, Spanish, Italian, French, Hungarian and Turkish. The number on Set language interface is sequence number of these five languages, the sequence number and its corresponding language are showing in Table below:

Language	Sequence Number
Italian	0
English	1
German	2
Spanish	3
French	4
Hungarian	5
Turkish	6

### 7.2.5 Set inverter time

1. If you want to set inverter time, repeat the steps as described in section 7.2.3.
2. When LCD displays 'INPUT 123:123', triple knock to enter the setting interface.
3. Single knock until LCD displaying 'xxxx/xx/xx xx:xx', and then double knock to enter the setting status, the numbers begin to flash. Single knock to change the number, each knock makes the flashing number add '1', and double knock to shift to next number setting. When setting finishes, wait for 30s or triple knock to save your setting.

4505.5VA 4485.5W  
2015/09/03 15:11

### 7.2.6 Inverter faulty messages

When system faulty or inverter error occurred, inverter will display faulty message or error code on its LCD screen.

### 7.2.7 AC Error Record Checking

When the LCD stays bright, single knock to 'AC Error Record', and then double knock to enter the checking status. Single knock to check each error item, triple knock can exit.

1. If the inverter connects with PV panel arrays and the input voltage is higher than 100Vdc, while the AC grid is not connected yet, LCD will display messages in order as below:

Growatt Inverter"-> "NO AC CONNECTION". The display repeats "NO AC CONNECTION" and the LED will be red.

2. Turn on the AC breaker or close the fuse between inverter and grid, the system will operate normally.

3. Under normal operating conditions, the LCD displays 'xxxx.xVA xxx.x W' at State info, this is the power fed into grid. LED turns green.

4. Finish commissioning.

### 7.2.8 Auto test (only for Italy)

Knock to make the display bright → knock to "Enable Auto test" → double knock to enter "Waiting to start" → knock to start auto test and wait for the test result.

### 7.2.9 Communication Type choice

If you select RS232 or External wireless, you must set the 2-PIN switch to different status. The 2-PIN switch is located beside the RS232 interface, as the figure below.

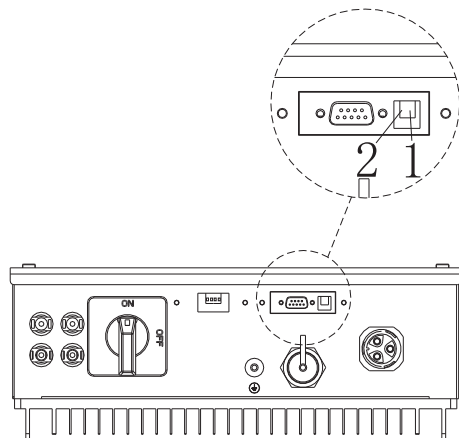

1. When 'RS232' is selected, you have to set PIN1 of the switch downward to OFF.

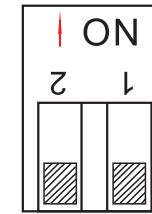

2. When 'Exter wireless' is selected, you have to set PIN1 of the switch upward to ON.

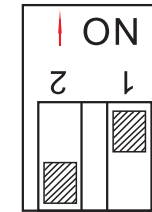

## 7.3 Communications

### 7.3.1 RS232 (standard)

RS 232 could be chosen for ShineNet ,WiFi Module.

### 7.3.2 External WiFi (Optional)

WIFI module (it is available from Growatt) can be used as an optional monitoring scheme. More details refer to the WIFI module manual.

## 8 Start-Up and shut down the inverter

### 8.1 Start-Up the inverter

1. Connect the AC breaker of the inverter.
2. Turn on the dc switch, and the inverter will start automatically when the input voltage is higher than 90V.

### 8.2 Turn-off the Inverter

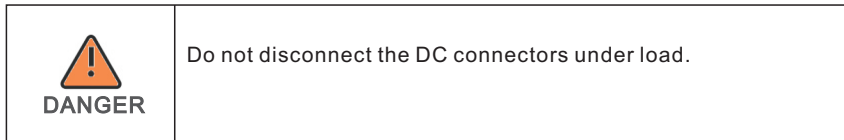

Turn –off the inverter step:

1. Disconnect the line circuit breaker from single-phases grid and prevent it from being reactivated.
2. Turn off the dc switch.
3. Check the inverter operating status.
4. Waiting until LED, display have go out, the inverter is shut down.

## Maintenance and Cleaning 9

### 9.1 Checking Heat Dissipation

If the inverter regularly reduces its output power due to high temperature, please improve the heat dissipation condition. Maybe you need to clean the heat sink.

### 9.2 Cleaning the Inverter

If the inverter is dirty, turn-off the AC breaker and DC switch ,waiting the inverter shut down ,then clean the enclosure lid, the display, and the LEDs using only a wet cloth. Do not use any cleaning agents (e.g. solvents or abrasives).

### 9.3 Checking the DC Disconnect

Check for externally visible damage and discoloration of the DC Disconnect and the cables at regular intervals. If there is any visible damage to the DC Disconnect, or visible discoloration or damage to the cables, contact the installer.

Once a year, turn the rotary switch of the DC Disconnect from the On position to the Off position 5 times in succession. This cleans the contacts of the rotary switch and prolongs the electrical endurance of the DC Disconnect.

# 10 Trouble shooting

Sometimes, the PV inverter does not work normally, we recommend the following solutions for common troubleshooting. The following table can help the technician to understand the problem and take action.

## 10.1 Warnings(W)

Warnings(W) identify the current status of the Growatt MTL-S. Warnings do not relate to a fault. When a (W) with a number after it appears in the display, it indicates a Warning Code and is usually cleared through an orderly shutdown/reset or a self corrective action performed by the inverter. See the (W) codes in the

Error message	Description	Suggestion
No AC Connection	No utility grid connected or utility grid power failure	1.Check AC wiring. 2.Contact Growatt.
AC V Outrange	Utility grid voltage is out of permissible range.	1.Check grid voltage. 2.If the error message still exists despite the grid voltage being within the tolerable range, contact Growatt.
AC F Outrange	Utility grid frequency out of permissible range.	1.Check grid frequency. 2.If the error message is displayed despite the grid frequency being within the tolerable range, contact Growatt.
Over Temperature	Temperature outrange	1.check the inverter operation state 2.If the error message is displayed still,please contact Growatt.
PV Isolation Low	Insulation problem	1.Check if panel enclosure ground properly. 2.Check if inverter ground properly. 3.Check if the DC breaker gets wet. 4.If the error message is displayed despite the above checking passed, contact Growatt.
Output High DCI	Output current DC offset too high	1.Restart inverter. 2.If error message still exists,contact Growatt.
Residual I High	Leakage current too high	1.Restart inverter. 2.If error message still exists, contact Growatt.
PV Voltage High	The DC input voltage is exceeding the maximum tolerable value.	Disconnect the DC switch immediately.
Auto Test Failed	Auto test didn't passed.	Contact power company, By they decide whether to manually cancel.

## 10.2 Errors(E)

Errors(E) codes identify a possible equipment failure, fault or incorrect inverter setting or configuration. Any and all attempts to correct or clear a fault must be performed by qualified personnel. Typically, the (E) code can be cleared once the cause or fault is removed. Some of the (E) codes, Error as indicated in the table below, may indicate a fatal error and require you to contact the supplier or the Growatt to replace a new one.

Error code	Description	Suggestion
Error: 101	Communication fault Slave processor can't receive data from Master processor.	1.Restart inverter 2.If error message still exists, contact Growatt.
Error: 102	Consistent fault. Data received by Master and Slave processor are different. The reason can be utility grid voltage or frequency change frequently.	1.Restart inverter. 2.If error message appears frequently or error message still exists after replacement, check utility grid. f you require help, contact Growatt. 3.If error message still exists, contact Growatt.
Error: 111	PE abnormal	1.Check PE,to ensure that the PE line contact good. 2.Check the L and the N line to ensure that they are not reversed. 3.Restart inverter. 4.If error message still exisits,contact Growatt.
Error: 116	EEPROM fault	Contact Growatt.
Error: 117	Relay fault	Contact Growatt.
Error: 118	Init model fault	Contact Growatt.
Error: 119	GFCI Device Damage	Contact Growatt.
Error: 120	HCT fault	Contact Growatt.
Error: 121	Communication fault. Master processor can't receive data from Slave processor.	1.Restart the inverter 2.If error message still exists, contact Growatt.
Error: 122	Bus voltage fault	Contact Growatt.

Note : The latest 5 NS(Network and System) protection records can be read by LCD or communication software. An interruption of  $\leq 3$  Sec to the power supply does not lead to any loss of fault records (according to VDE-AR-N 4105, cl.6.5.1).



# 11 Manufacturer Warranty

Please refer to the warranty card.

# Decommissioning 12

## 12.1 Dismantling the Inverter

1. Disconnect the inverter as described in section 8.
2. Remove all connection cables from the inverter.

 <b>CAUTION</b>	Danger of burn injuries due to hot enclosure parts! Wait 20 minutes before disassembling until the housing has cooled down.
---	--

3. Screw off all projecting cable glands.
4. Lift the inverter off the bracket and unscrew the bracket screws.

## 12.2 Packing the Inverter

If possible, always pack the inverter in its original carton and secure it with tension belts. If it is no longer available, you can also use an equivalent carton. The box must be capable of being closed completely and made to support both the weight and the size of the inverter.

## 12.3 Storing the Inverter

Store the inverter in a dry place where ambient temperatures are always between -25°C and +60°C.

## 12.4 Disposing of the Inverter



Do not dispose of faulty inverters or accessories together with household waste. Please accordance with the disposal regulations

# 13 Technical Data

## 13.1 Specification

Model	Growatt 2500MTL-S	Growatt 3000MTL-S	Growatt 3600MTL-S
<b>Specifications</b>			
<b>Input data</b>			
Max. recommended PV power(for module STC)	2900W	3500W	4100W
Max. DC voltage	500V	500V	550V
Start voltage	100V	100V	100V
PV voltage range	70V-500V	70V-500V	70V-550V
MPP voltage range/ nominal voltage	80V-500V /360V	80V-500V /360V	80V-550V /360V
Full load dc voltage range	130V-450V	160V-450V	190V-500V
Max. input current of trackerA/trackerB	10A/10A	10A/10A	10A/10A
Max. input current per string of tracker A/tracker B	10A/10A	10A/10A	10A/10A
Number of independent MPP inputs / strings per MPP input	2/1	2/1	2/1
<b>Output (AC)</b>			
Nominal AC output power	2500W	3000W	3600W
Max. AC apparent power	2500VA	3000VA	3600VA
Max. output current	11.3A	13.6A	16.3A
AC nominal voltage; range	220V/230V/240V; 180Vac-280Vac		
AC grid frequency; range	50,60Hz;±5 Hz	50,60Hz;±5 Hz	50,60Hz;±5 Hz
Phase factor at rate power	1	1	1
Displacement power factor, configurable*	0.8leading... 0.95lagging	0.8leading... 0.95lagging	0.8leading... 0.95lagging
THDI	<3%	<3%	<3%
AC connection	Single phase	Single phase	Single phase
<b>Efficiency</b>			
Max. efficiency	97.4%	97.4%	97.5%
Euro - weighted efficiency	97%	97%	97%
MPPT efficiency	99.5%	99.5%	99.5%

Protection devices	Growatt 2500MTL-S	Growatt 3000MTL-S	Growatt 3600MTL-S
DC reverse polarity protection	yes	yes	yes
DC switch rating for each MPPT	yes	yes	yes
Output Over current protection	yes	yes	yes
Output Overvoltage Protection-varistor	yes	yes	yes
Ground fault monitoring	yes	yes	yes
Grid monitoring	yes	yes	yes
Integrated all - pole sensitive leakage current monitoring unit	yes	yes	yes

## General Data

Dimensions (W / H / D)	355/419/138mm	355/419/138mm	355/419/138mm
Weight	14KG	14KG	14KG
Operating temperature range	-25...+60°C (-13...+ 140°F) with derating above 45°C (113°F)		
Noise emission (typical)	≤ 25 dB(A)	≤ 25 dB(A)	≤ 25 dB(A)
Altitude	Up to 2000m (6560ft) without power derating		
Relative humidity	100%	100%	100%
Self-Consumption night	< 0.5 W	< 0.5 W	< 0.5 W
Topology	transformerless	transformerless	transformerless
Cooling concept	Natural	Natural	Natural
Environmental Protection Rating	IP 65	IP 65	IP 65

## Features

DC connection:	H4/MC4(opt)	H4/MC4(opt)	H4/MC4(opt)
AC connection	Connector	Connector	Connector
Display	LCD	LCD	LCD
Interfaces: Rs232 / RF/Wi-Fi/Ethernet	yes/opt/ opt/opt	yes/opt/ opt/opt	yes/opt/ opt/opt
Warranty: 5 years / 10 years	yes /opt	yes /opt	yes /opt
Certificates and approvals	CE, IEC62109, VDE0126-1-1, G83, G59, AS4777, VDE-AR-N-4105, NBT32004-2013, EN50438, CEI-021, INMETRO		

Model	Growatt 4200MTL-S	Growatt 5000MTL-S	Growatt 5500MTL-S
<b>Specifications</b>			
<b>Input data</b>			
Max. recommended PV power(for module STC)	4800W	5300W	5750W
Max. DC voltage	550V	550V	550V
Start voltage	100V	100V	100V
PV voltage range	70V-550V	70V-550V	70V-550V
MPP voltage range/nominal voltage	80V-550V/360V	80V-550V/360V	80V-550V /360V
Full load dc voltage range	150V-500V	160V-500V	175V-500V
Max. input current of trackerA/trackerB	15A/15A	15A/15A	15A/15A
Max. input current per string of tracker A/tracker B	15A/15A	15A/15A	15A/15A
Number of independent MPP inputs / strings per MPP input	2/1	2/1	2/1
<b>Output (AC)</b>			
Nominal AC output power	4200W	4600W	5000W
Max. AC apparent power	4200VA	4600VA	5000VA
Max. output current	19A	20.9A	22.7A
AC nominal voltage; range	220V/230V/240V; 180Vac-280Vac	220V/230V/240V; 180Vac-280Vac	220V/230V/240V; 180Vac-280Vac
AC grid frequency; range	50,60Hz;±5 Hz	50,60Hz;±5 Hz	50,60Hz;±5 Hz
Phase factor at rate power	1	1	1
Displacement power factor, configurable*	0.8leading... 0.95lagging	0.8leading... 0.95lagging	0.8leading... 0.95lagging
THDI	<3%	<3%	<3%
AC connection	Single phase	Single phase	Single phase
<b>Efficiency</b>			
Max. efficiency	97.5%	97.5%	97.5%
Euro - weighted efficiency	97%	97%	97%
MPPT efficiency	99.5%	99.5%	99.5%

	Growatt 4200MTL-S	Growatt 5000MTL-S	Growatt 5500MTL-S
<b>Protection devices</b>			
DC reverse polarity protection	yes	yes	yes
DC switch rating for each MPPT	yes	yes	yes
Output Over current protection	yes	yes	yes
Output Overvoltage Protection-varistor	yes	yes	yes
Ground fault monitoring	yes	yes	yes
Grid monitoring	yes	yes	yes
Integrated all - pole sensitive leakage current monitoring unit	yes	yes	yes
<b>General Data</b>			
Dimensions (W / H / D)	355/419/138mm	355/419/158mm	355/419/158mm
Weight	14KG	14.5KG	14.5KG
Operating temperature range	-25...+60°C (-13...+ 140°F) with derating above 45°C (113°F)		
Noise emission (typical)	≤ 25 dB(A)	≤ 25 dB(A)	≤ 25 dB(A)
Altitude	Up to 2000m (6560ft) without power derating		
Relative humidity	100%	100%	100%
Self-Consumption night	< 0.5 W	< 0.5 W	< 0.5 W
Topology	transformerless	transformerless	transformerless
Cooling concept	Natural	Natural	Natural
Environmental Protection Rating	IP 65	IP 65	IP 65
<b>Features</b>			
DC connection:	H4/MC4(opt)	H4/MC4(opt)	H4/MC4(opt)
AC connection	Connector	Connector	Connector
Display	LCD	LCD	LCD
Interfaces: Rs232/ RF/Wi-Fi/Ethernet	yes/opt/ opt/opt	yes/opt/ opt/opt	yes/opt/ opt/opt
Warranty: 5 years / 10 years	yes /opt	yes /opt	yes /opt
Certificates and approvals	CE,IEC62109,VDE0126-1-1,G83,G59,AS4777,VDE-AR-N-4105, NBT32004-2013,EN50438,CEI-021,INMETRO		
	* 0.95leading...0.95lagging with VDE-AR-N 4105		
	0.95leading...0.95lagging with CEI 0-21 (System power less than 6KW)		
	0.9leading...0.9lagging with CEI 0-21 (System power larger than 6KW)		

## 13.2 DC connector info

DC connector info	H4/MC4(opt)
-------------------	-------------

## 13.3 Torque

Enclosure lid screws	7kg.cm
Shell and RS232 screws	7kg.cm
AC terminal	6kg.cm
M6 socket head cap screws for securing the enclosure at the bracket	20kg.cm
Additional ground screws	20kg.cm

## 13.4 Accessories

In the following table you will find the optional accessories for your product. If required, you can order these from GROWATT NEW ENERGY TECHNOLOGY CO.,LTD or your dealer.

Name	Brief description
External WiFi	

Shipped to a Growatt service centre for repair, or repaired on-site, or exchanged for a replacement device of equivalent value according to model and age.

The warranty shall not cover transportation costs in connection with the return of defective modules. The cost of the installation or reinstallation of the modules shall also be expressly excluded as are all other related logistical and process costs incurred by all parties in relation to this warranty claim.

Installation with multiple inverters on a single phase system

(A) Single inverter

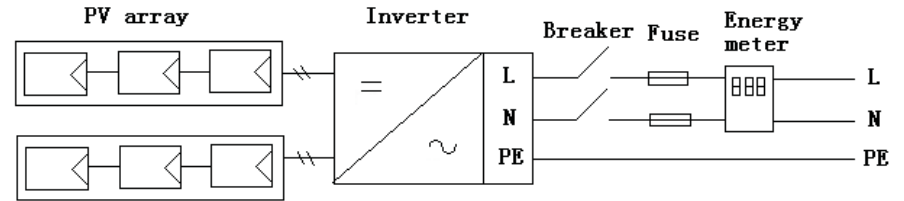

(B) multi inverter

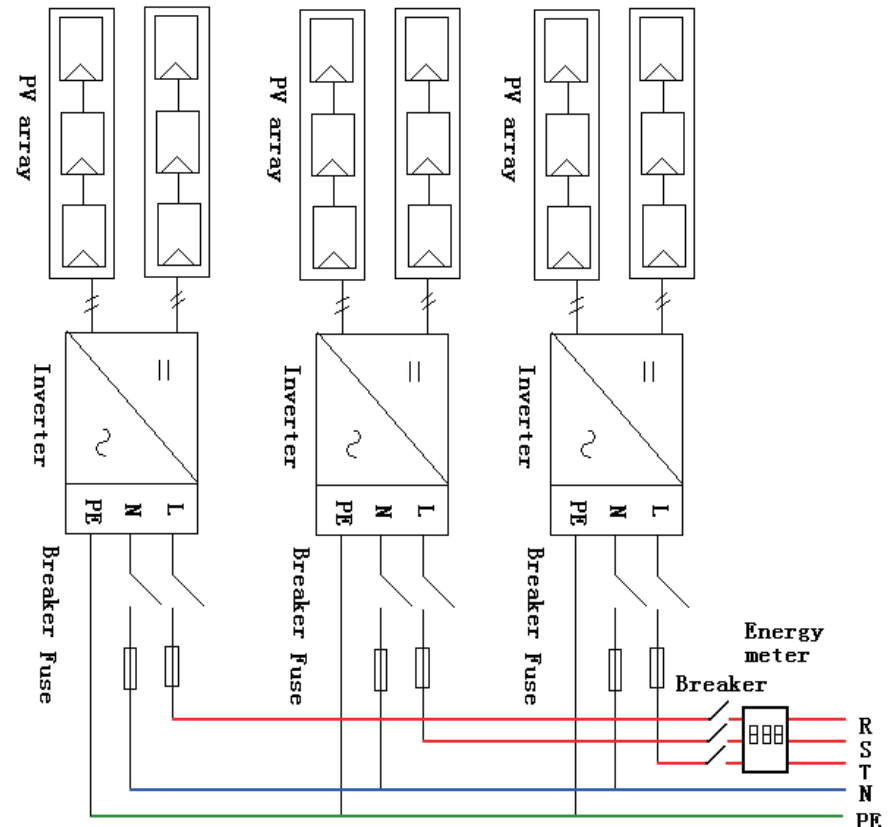

## 15.1 List

- **Certified countries**

With the appropriate settings, the unit will comply with the requirements specified in the following standards and directives .

- VDE0126-1-1
- VDE-AR-N4105
- CEI 0-21
- CE
- G59
- G83
- As4777
- NBT32004-2013
- IEC-62109
- EN 50438

GROWATT can preset special grid parameters for other countries installation locations according to customer requests after evaluation by GROWATT. You can make later modifications yourself by changing software parameters with respective communication products (e.g. shinebus or shineNet ect). To change the grid-relevant parameters, you need a personal access code, if you need it ,please contact with GROWATT.

## 15.2 Download Address

[www.ginverter.com](http://www.ginverter.com)

If you have technical problems about our products, contact the GROWATT Serviceline. We need the following information in order to provide you with the necessary assistance:

- Inverter type
- Serial number of the inverter
- Event number or display message of the inverter
- Type and number of PV modules connected
- Optional equipment

### GROWATT NEW ENERGY TECHNOLOGY Co.,LTD

- Building B, Jiayu Industrial Park, #28, GuangHui Road, Shiyan Street, Baoan District, Shenzhen, P.R.China
- T 0755-29515888
- F 0755-27472131
- E [service@ginverter.com](mailto:service@ginverter.com)
- W [www.ginverter.com](http://www.ginverter.com)

# Annex:

## Auto test (only for Italy):

Knock to make the display bright → knock to “Enable Auto test” → double knock to enter “Waiting to start” → the inverter will start auto test and wait for the test result. When the inverter start auto test, the LCD will display below message:

